

PARTS LIST / LISTE DES PIÈCES / LISTA DE PIEZA

ITEM / NO D'ARTICLE / ARTICULO NO.: 1498DB-6

DESCRIPTION / DESCRIPCION : LANDSCAPE MIRROR / MIROIR HORIZONTAL / ESPEJO HORIZONTAL

**WARNING**



Children have died from furniture tipover. To reduce the risk of furniture tipover .

- ALWAYS install tipover restraint provided
- NEVER put a TV on this product .
- NEVER allow children to stand, climb or hang on drawers, doors, or shelves .
- NEVER open more than one drawer at a time.
- Place heaviest items in the lowest drawers.

*This is a permanent label.  
Do not remove!*

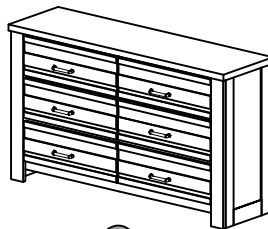

A

x1 Dresser  
x1 Commode  
x1 Tocadoir

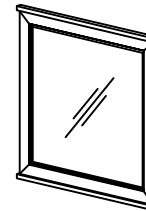

B

x1 Mirror  
x1 Miroir  
x1 Espejo



C

x2 Mirror Support \*  
x2 Supporte de miroir  
x2 Soporte del espejo

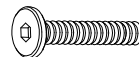
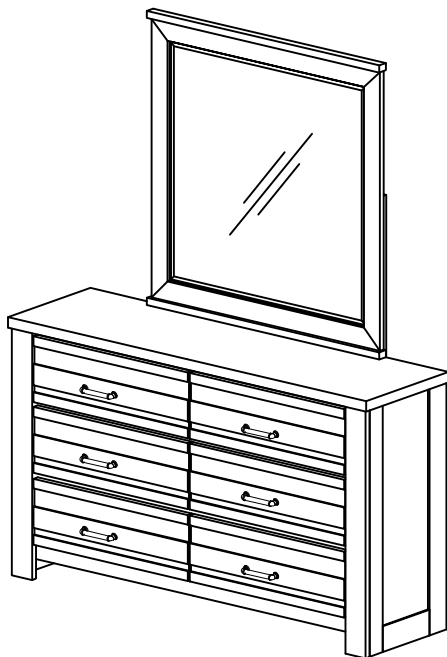

1

x8 Allen bolt M6\*35mm \*  
x8 Vis à tête creuse hexagonale M6\*35mm  
x8 Perno Allen M6\*35mm



2

x8 Flat washer Ø16\*2mm \*  
x8 Rondelle plate Ø16\*2mm  
x8 Arandela plana Ø16\*2mm



3

x8 Lock washer Ø11\*2mm \*  
x8 Rondelle de blocage Ø11\*2mm  
x8 Arandela de Seguridad Ø11\*2mm



4

x1 Allen key 4mm \*  
x1 Clé hexagonale 4mm  
x1 Llave Allen 4mm

**\*Replaceable Part**



ASSEMBLY INSTRUCTION / NOTICE DE MONTAGE/ INSTRUCCIONES DE MONTAJE

ITEM / NO D'ARTICLE / ARTICULO NO.: 1498DB-6

DESCRIPTION / DESCRIPCION : LANDSCAPE MIRROR / MIROIR HORIZONTAL / ESPEJO HORIZONTAL

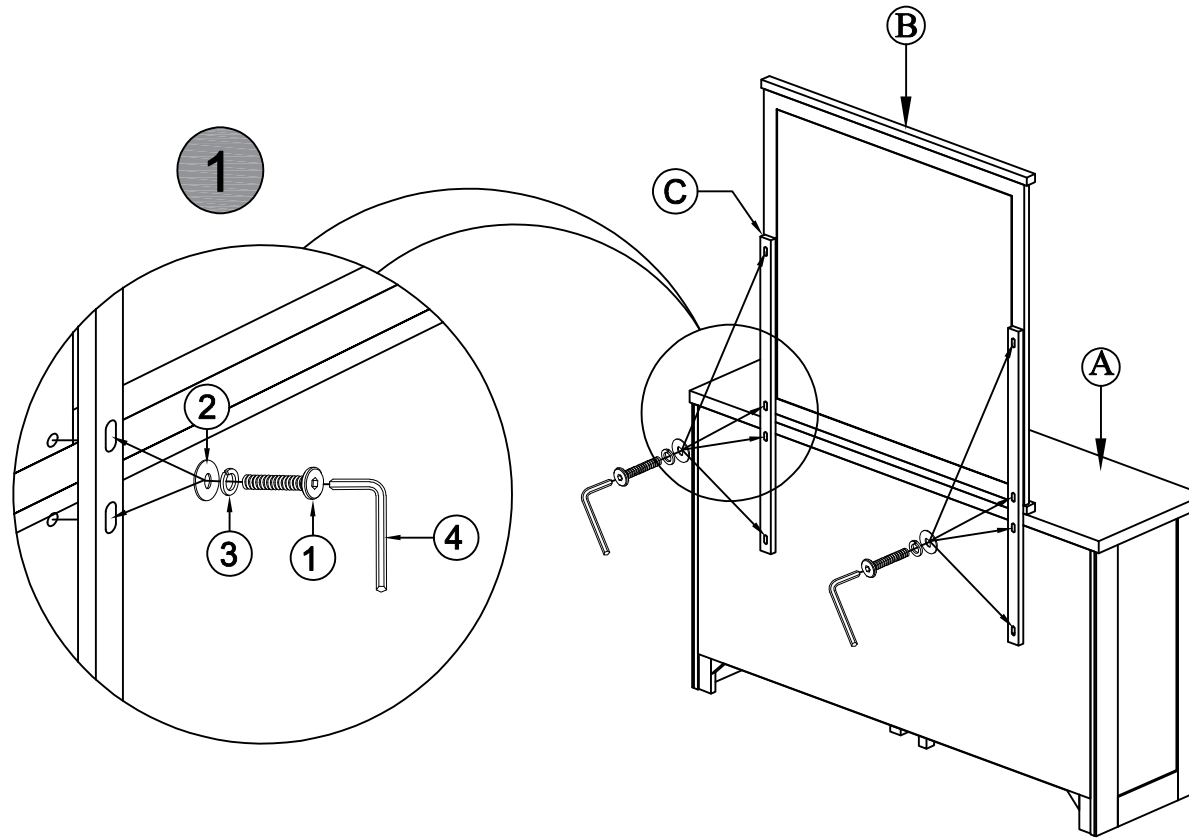

***\*Replaceable Part***



REPLACEABLE PART/ PARTIE REMPLACABLE/ PARTE REEMPLAZABLE  
ITEM / NO D'ARTICLE / ARTICULO NO.: 1498DB-6

DESCRIPTION / DESCRIPCION : LANDSCAPE MIRROR / MIROIR HORIZONTAL / ESPEJO HORIZONTAL

**WARNING**



Children have died from furniture tipover. To reduce the risk of furniture tipover .

- ALWAYS install tipover restraint provided
- NEVER put a TV on this product .
- NEVER allow children to stand, climb or hang on drawers, doors, or shelves .
- NEVER open more than one drawer at a time.
- Place heaviest items in the lowest drawers.

*This is a permanent label.  
Do not remove!*



-Mirror support \*  
supporte de miroir  
soporte del espejo

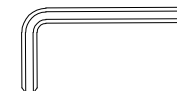
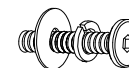

-Hardware kit list \*  
liste des pièces de quincailles  
lista del kit de materiales

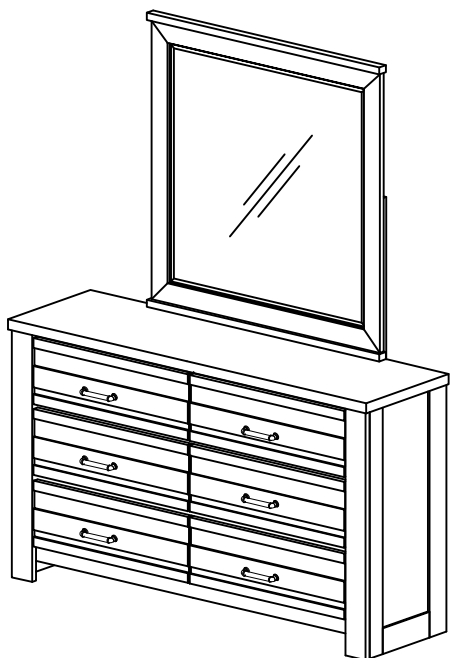

**\*Replaceable Part**