



ASSEMBLY INSTRUCTIONS/INSTRUCTION D'ASSEMBLAGE



Recliner - Fauteuil Inclinable

99990-1RR

Thank you for purchasing this product from Mazin Furniture. Please take the time to read and follow the instructions below. Check that you have all parts and hardware before assembly. Parts apparently missing are often found in the packing materials. If you do not have all the parts listed, call us and they will be sent to you immediately. Should parts be damaged during transportation, give us a call and we will replace the damaged part as soon as possible.

Merci d'avoir acheté ce produit de Mazin Furniture. Veuillez lire et suivre les instructions ci-dessous. Vérifiez avant le montage que vous avez toutes les pièces et fixations. Les pièces qui semblent manquer se trouvent souvent dans les matériaux d'emballage. Si vous n'avez pas toutes les pièces de la liste, demandez à votre détaillant et nous vous les enverrons immédiatement.

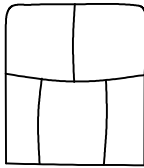
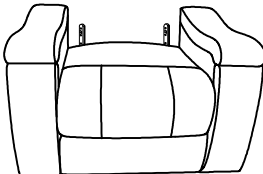
PARTS LIST/LISTE DE PIÈCES

A		1PC	B		1PC
C		1PC	D		1PC

STEP1/ÉTAPE1

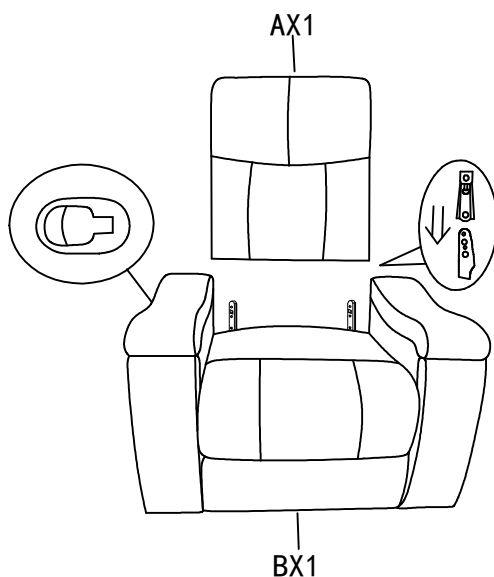

STEP2/ÉTAPE2

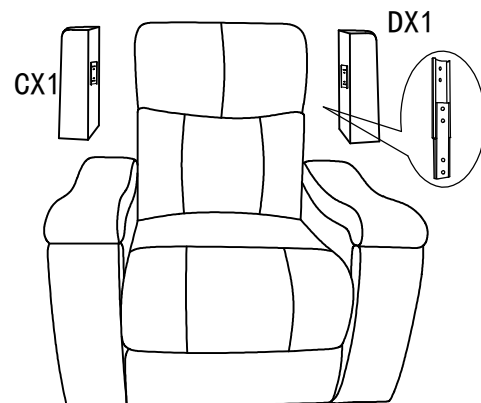

STEP3/ÉTAPE3

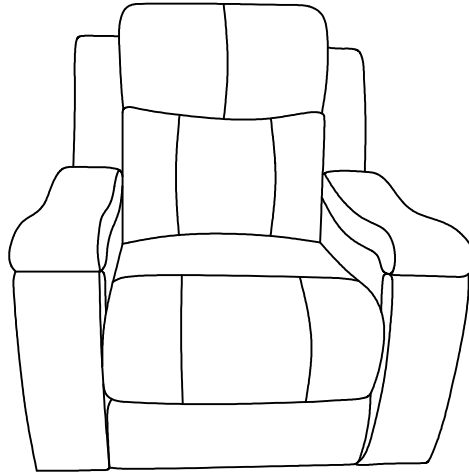

DONOT TIGHTEN BOLTS UNTIL COMPLETELY ASSEMBLED.

NE PAS SERRER LES BOULONS JUSQU' À CE QUE LE MONTAGE SOIT COMPLETMENT TERMINE



It is recommended to install protective pads under all legs and supports to avoid damage or scratches when placing furniture on a wood floor or other hard surface, and to limit indentation and prevent discoloration if placing on carpet



Il est recommandé de placer des coussins protecteurs sous tous les pieds et toutes les bases des meubles pour éviter d'endommager ou d' égratigner les planchers en bois ou autres surfaces dures, et pour limiter l' empreinte et empêcher la décoloration quand les meubles reposent sur la moquette.