







## ASSEMBLY INSTRUCTIONS / LES INSTRUCTIONS D'ASSEMBLAGE 99942-2L/-5R/-B LHF LOVESEAT CAUSEUSE DROITE

Thank you for purchasing this product from Mazin Furniture. Please take the time to read and follow the instructions below. Check that you have all parts and hardware before assembly. Parts apparently missing are often found in the packing materials. If you do not have all the parts listed, have your dealer contact us and they will be sent to you immediately.

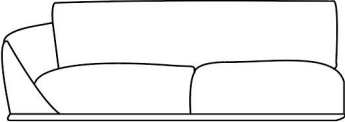
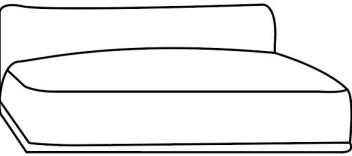
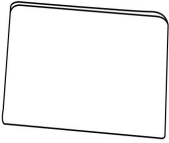
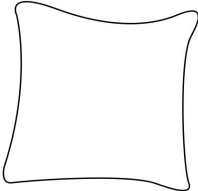
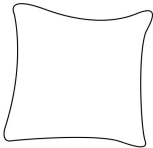
Merci d'avoir acheté ce produit de Mazin Furniture. Veuillez lire et suivre les instructions ci-dessous. Vérifiez avant le montage que vous avez toutes les pièces et fixations. Les pièces qui semblent manquer se trouvent souvent dans les matériaux d'emballage. Si vous n'avez pas toutes les pièces de la liste, demandez à votre détaillant et nous vous les enverrons immédiatement.

### PARTS LIST / LISTE DE PIÈCES

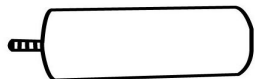
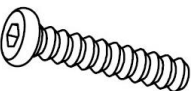
A		1pc	1 Arm loveseat seat / Siège
B		1pc	Chaise seat / Siège
C		2pc	Back Cushion / Dossier de dos
D		2pc	Back Cushion / Dossier de dos
E		2pc	Pillow / Oreiller

F		1pc	Metal Leg / Pied
G		6pc	Metal Leg / Pied
H		2pc	Middle Leg / Pied
I		26pc	Bolt / Boulon
J		1pc	Allen Wrench / Clé allen

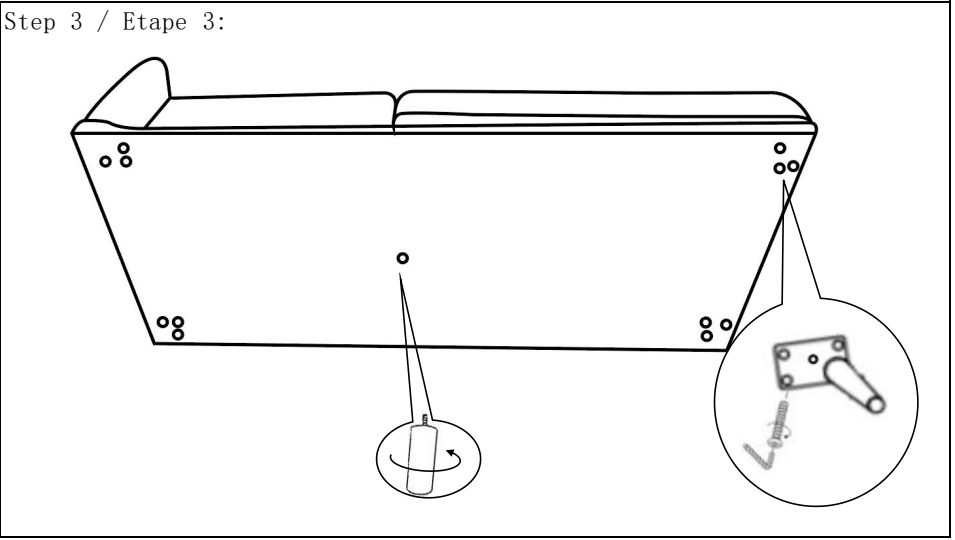
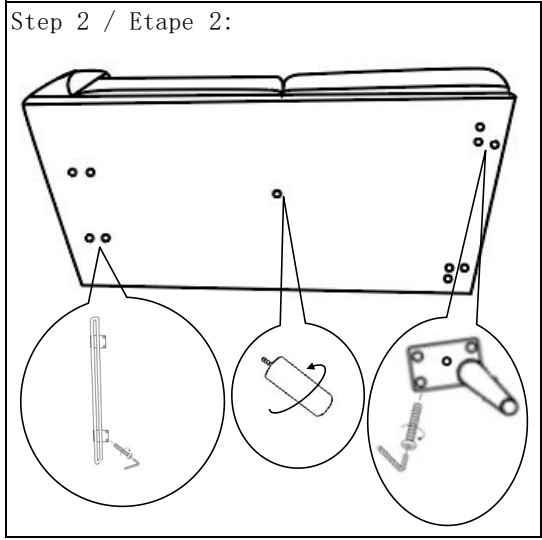
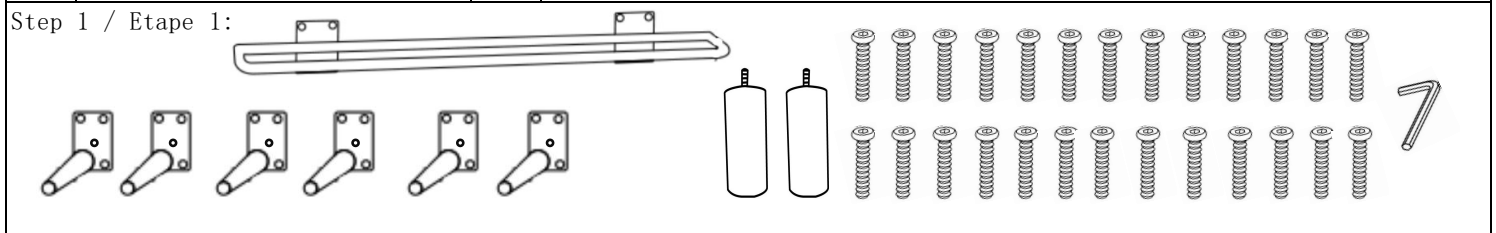

Step 4 / Etape 4:

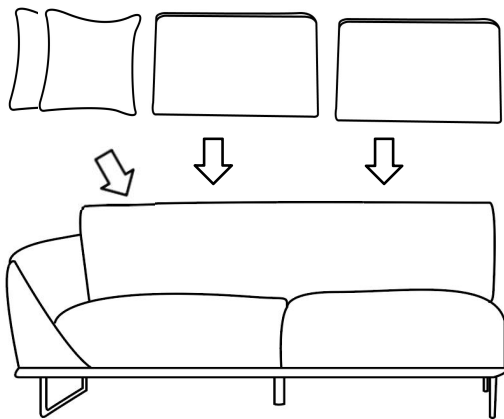

Step 5 / Etape 5:

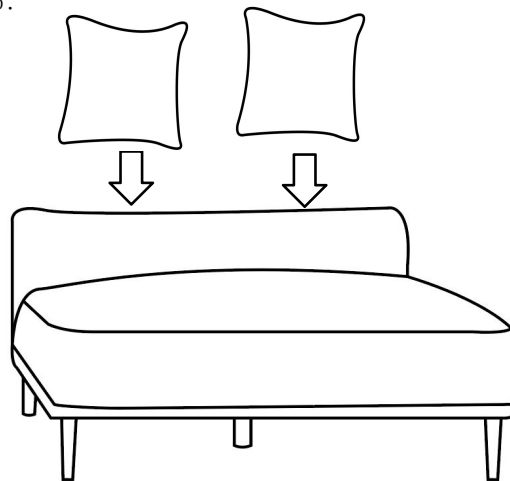

Step 6 / Etape 6:

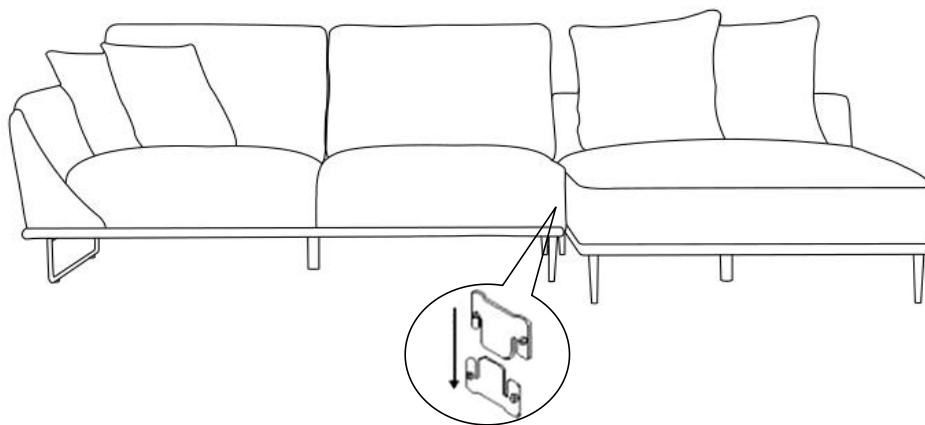

#### CARE INSTRUCTION FOR FABRIC:

In order to maintain the original appearance of your upholstery furniture, please follow the following procedures:

1. Avoid exposing furniture directly to sunlight or heating and air conditioning outlets
2. Vacuum or wipe with a soft cloth to remove dust
3. Clean the fabric with a professional cleanser.

#### INSTRUCTIONS D'ENTRETIEN POUR LE TISSU:

Afin de conserver l'aspect d'origine de vos meubles rembourrés, veuillez suivre les procédures suivantes:

1. Évitez d'exposer les meubles directement à la lumière du soleil ou aux prises de chauffage et de climatisation
2. aspirez ou essuyez avec un chiffon doux pour enlever la poussière
3. Nettoyez le tissu avec un nettoyant professionnel.

⚠ It is recommended to install protective pads under all legs and supports to avoid damage or scratches when placing furniture on a wood floor or other hard surface, and to limit indentation and prevent discoloration if placing on carpet.

⚠ Il est recommandé de placer des coussins protecteurs sous tous les pieds et toutes les bases des meubles pour éviter d'endommager ou d'égratigner les planchers en bois ou autres surfaces dures, et pour limiter l'empreinte et empêcher la décoloration quand les meubles reposent sur la moquette.