











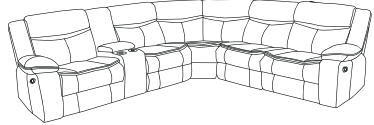

99918-CR  
Corner/Wedge Aurehyde/Coin/Wedge Aurehyde  
99918-2R  
RAF Loveseat /Causeuse droite  
99918-2LC  
LHF Loveseat / Causeuse gauche

HAVE A QUESTION? GIVE US A CALL. 1-800-363-0219 VOUS AVEZ UNE QUESTION? APPELEZ-NOUS AU  
1-800-363-0219

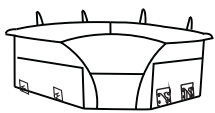
Thank you for purchasing this product from Mazin Furniture. Please take the time to read and follow the instructions below. Check that you have all parts and hardware before assembly. Parts apparently missing are often found in the packing materials. If you do not have all the parts listed, call us and they will be sent to you immediately. Should parts be damaged during transportation, give us a call and we will replace the damaged part as soon as possible.

Merci d'avoir acheté ce produit de Mazin Furniture. Veuillez lire et suivre les instructions ci-dessous. Vérifiez avant le montage que vous avez toutes les pièces et fixations. Les pièces qui semblent manquer se trouvent souvent dans les matériaux d'emballage si vous n'avez pas toutes les pièces de la liste, appelez-nous et nous vous les enverrons immédiatement. Si des pièces sont endommagées pendant le transport, appelez-nous et nous vous les remplacerons aussitôt que possible la pièce endommagée.

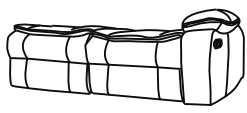
### PARTSLIST/LISTE DES PIÈCES

1		Seat with console/ Siège avec console	1PC	
2		Outside back cushion (console)/ Coussin de dossier extérieur (console)	1PC	
3		Inside back cushion (console)/ Coussin de dos intérieur (console)	1PC	
4		Console back cushion/ Coussin de dossier de console	1PC	
5		Corner seat/ Siège d'angle	1PC	
6		Corner back cushion/ Coussin de dossier d'angle	2PC	
7		Inside back cushion/ Coussin de dossier intérieur	1PC	
8		Outside back cushion/ Coussin de dossier extérieur	1PC	
9		Seat/Siège	1PC	
10		Ear cushions/ Coussinets d'oreille	2PC	
11		Handwheel/Volant	2PC	

Step 1/ Étape 1

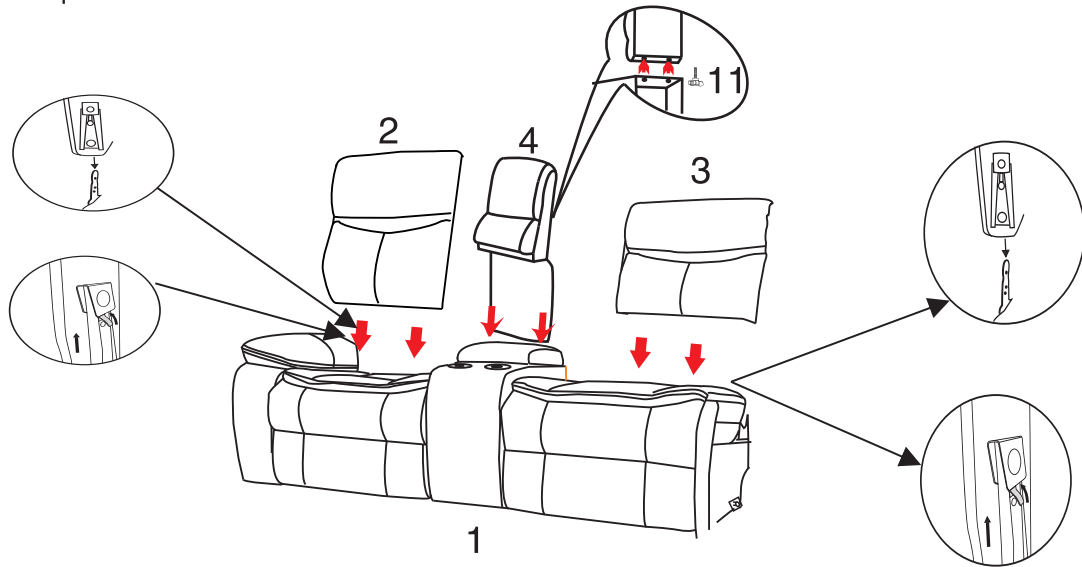

Step 2/ Étape 2

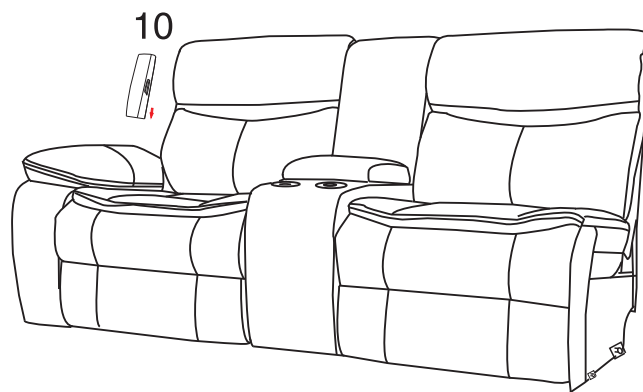

Step 3/ Étape 3

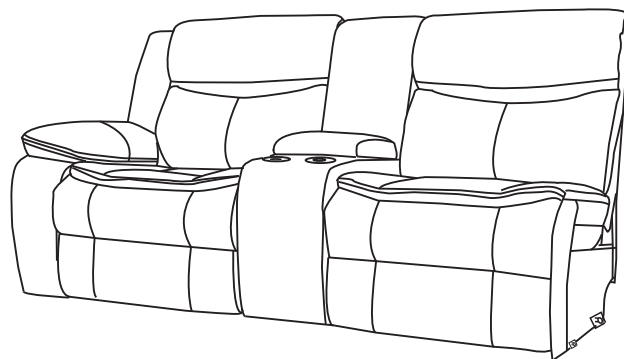

Step 4/ Étape 4

Step 4/ Etape 4

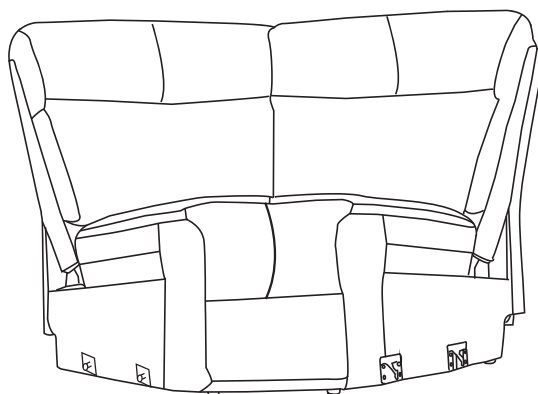
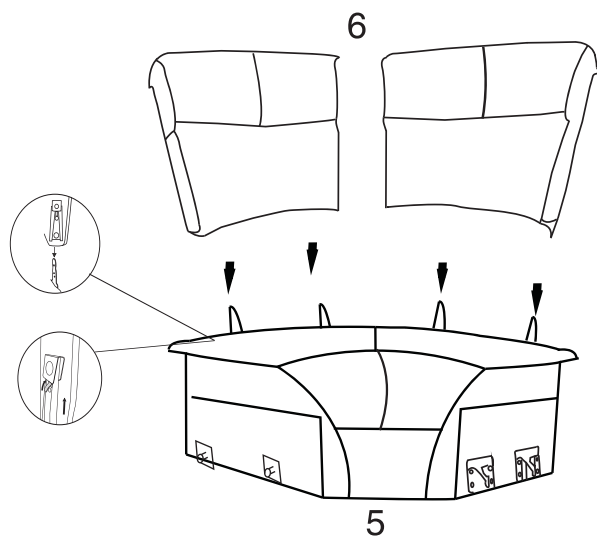

Step 5/ Étape 5

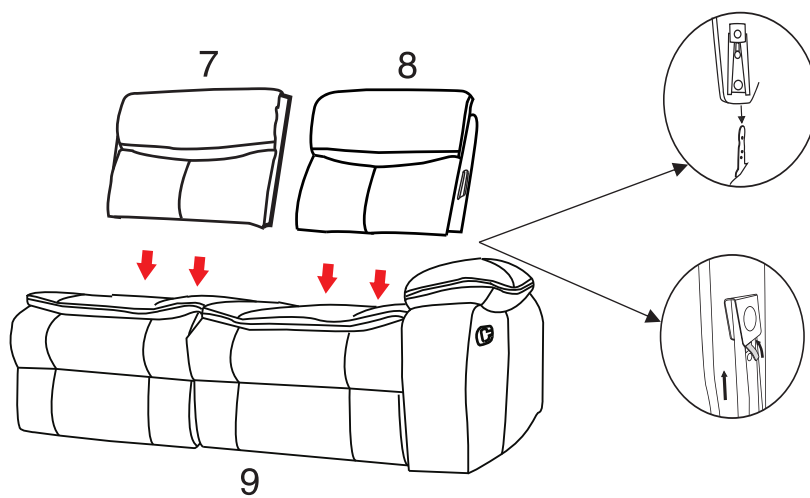

Step 6/ Étape 6

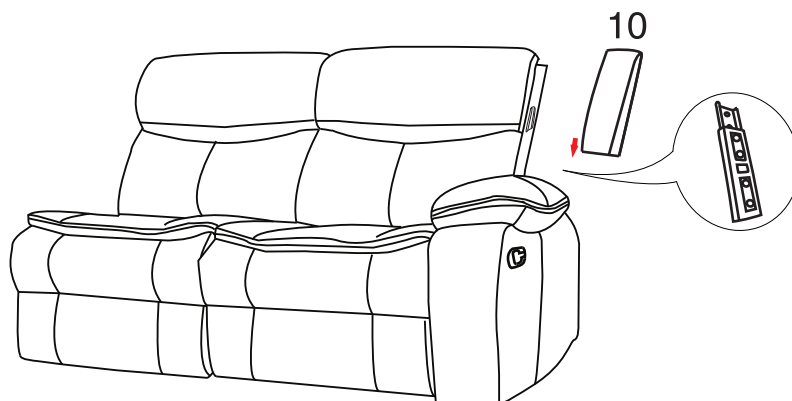

Step 7/ Étape 7

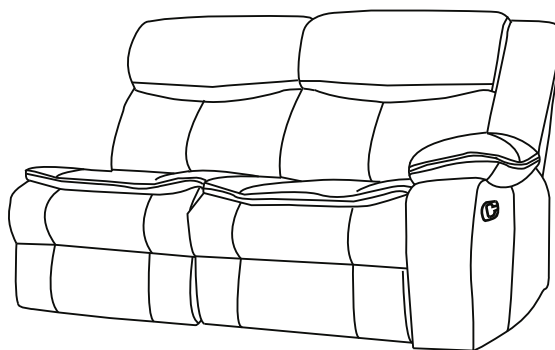

Step 8/ Étape 8

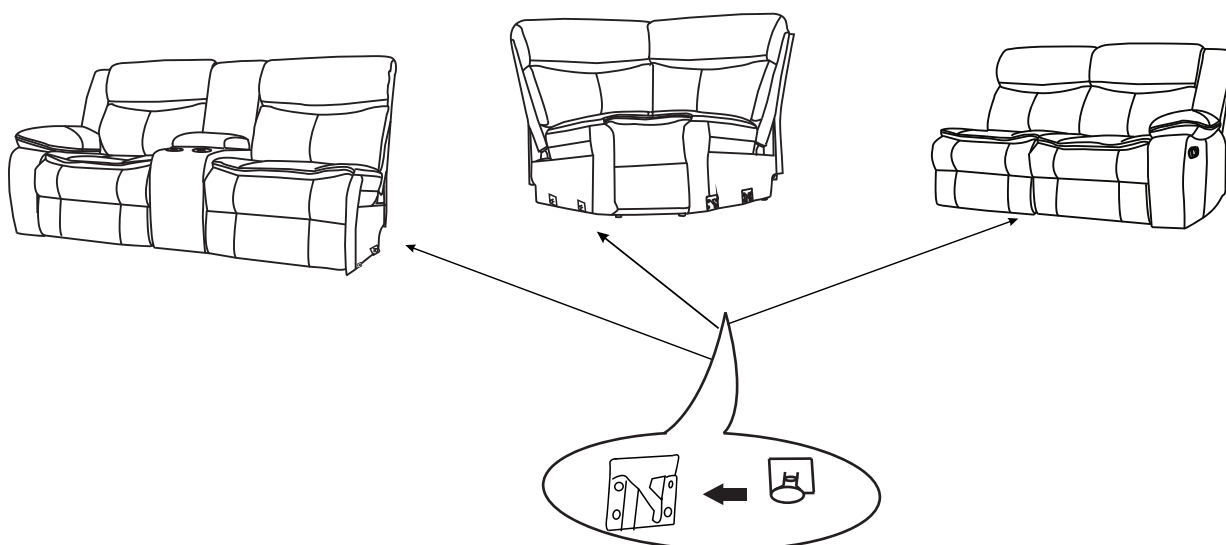

Step 9/ Étape 9

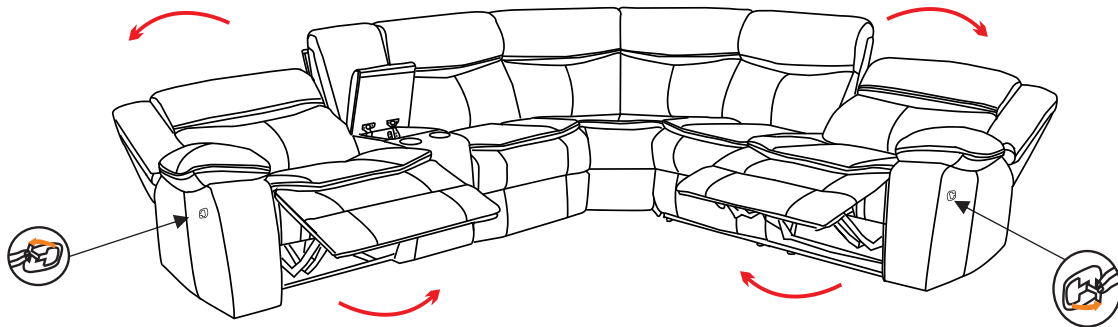

Step 10/ Étape 10

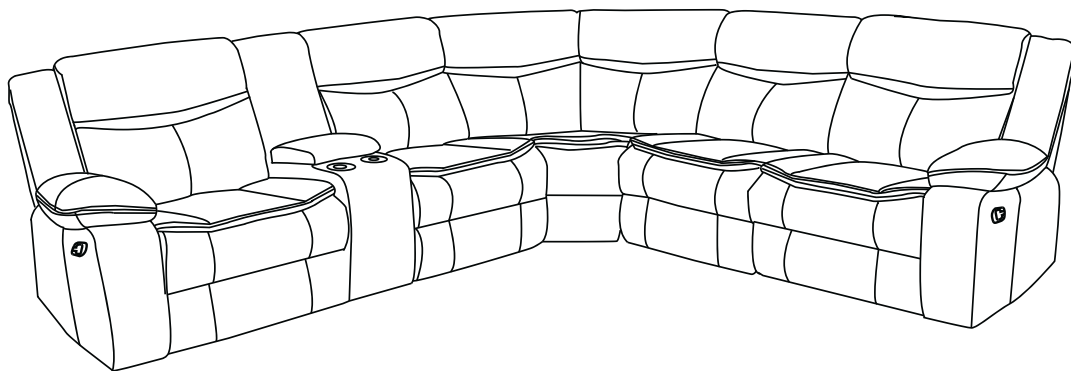

Align the male & female brackets.  
Push down tightly to secure.  
Alignez les supports.  
Poussez vers le bas pour fixer

It is recommended to install protective pads under all legs and supports to avoid damage or scratches when placing furniture on a wood floor or other hard surface, and to limit indentation and prevent discoloration if placing on carpet.

Il est recommandé de placer des coussins protecteurs sous tous les pieds et toutes les bases des meubles pour éviter d'égratigner les planchers en bois ou autres surfaces dures, et pour limiter l'empreinte et empêcher la décoloration quand les meubles reposent sur la moquette.