











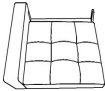

# Assembly Instruction

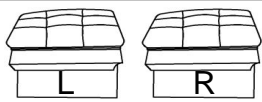
ITEM NO:9957GRY/CH-2

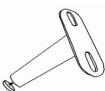
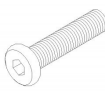
Loveseat, 2 pillows

**NOTE: Do not use power tools for assembly. Power tools increase the risk of over tightening which lead to splitting or cracking the wood.**

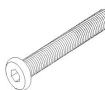
## COMPONENT LIST

| NO. | DRAWING  | QTY | DESCRIPTION            |
|-----|--|-----|------------------------|
| A   |                               | 1   | LSF SEAT FRAME         |
| B   |                               | 1   | RSF SEAT FRAME         |
| C   |                               | 2   | LSF/RSF BACK CUSHION   |
| D   |                               | 4   | PLASTIC LEG            |
| E   |                              | 2   | METAL MIDDLE LEG       |
| F   |  | 4   | BOLT(5/16"*1-3/8")     |
| G   |    | 6   | LOCK WASHER(1/2"*1/2") |
| H   |    | 6   | LOCK WASHER(4/5"*4/5") |
| I   |         | 1   | ALLEN KEY(1"*3")       |
| J   |  | 2   | BOLT(5/16"*2-1/5")     |
| K   |                             | 2   | PILLOW                 |

legs are packed with bubble bag and stored on the bottom of seat, please take out for assembly

Step 1 Secure the two individual seat frame (A&B) together with  
2 pcs bolt (J)

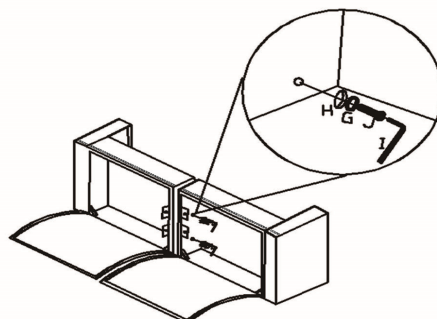

STEP 2:

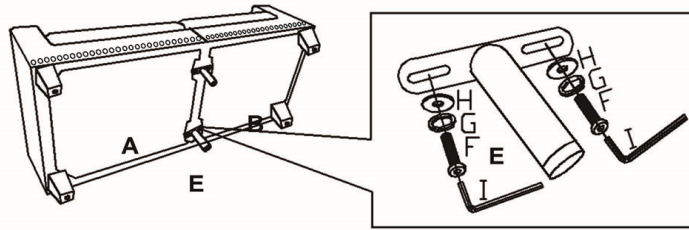

STEP 3:

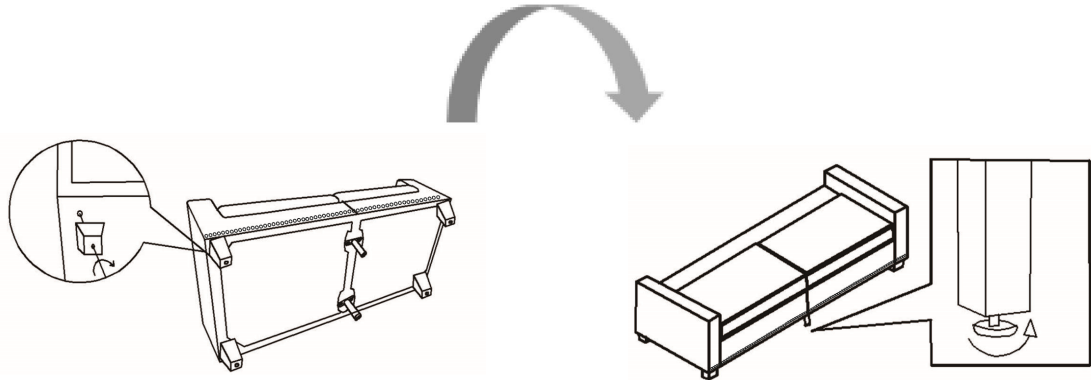

STEP 4:

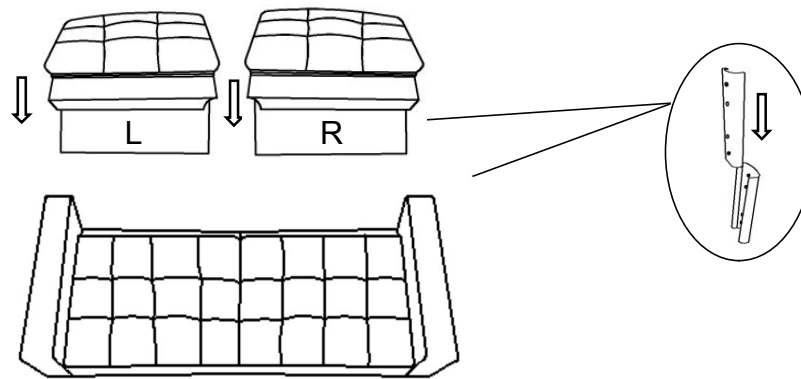

STEP 5: COMPLETED

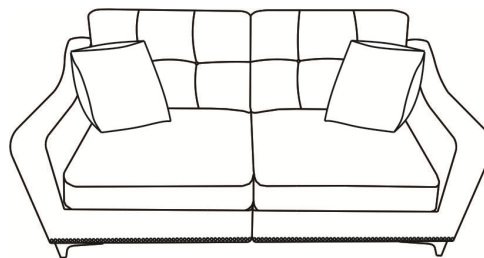

### CARE INSTRUCTION FOR 100% POLYESTER FURNITURE:

In order to maintain the original appearance of your 100% polyester furniture, please follow below care procedures:

- Avoid exposing furniture directly to sunlight or heating and air conditioning outlets. Sunlight and / or exposure to heating and air conditioning outlets will fade/damage 100% polyester. Do not place your upholstered furniture too close to windows, radiators, or vents, and be sure to use window treatments to block the sun's rays.
- Wipe with a soft brush to remove dust.
- Wipe 100% polyester with professional cleanser.



For items use on wooden floor, hard surfaces or carpets, it is recommended to install protective pads under all legs and supports to avoid/prevent from damages/scratches and discoloration.