



# Assembly Instruction

## RSF POWER RECLINING CHAISE WITH USB

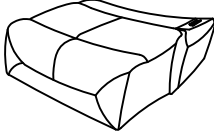
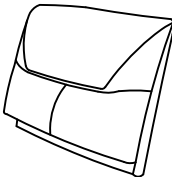

### ITEM NO.9579GRY/BRW-RCPW

NOTE: Do not use power tools for assembly. Power tools increase the risk of over tightening which lead to splitting or cracking the wood.

#### COMPONENT LIST

NO.	DRAWING	QTY	DESCRIPTION
A		1PC	SEAT
B		1PC	BACK REST
C		1PC	RSF ARMREST

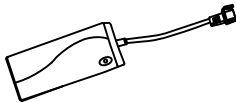
#### HARDWARE LIST

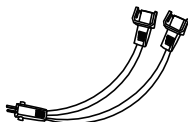
NO.	DRAWING	QTY	DESCRIPTION
1		1PC	ADAPTOR
2		1PC	PLUG WITH WIRE
3		1PC	Y-CABLE

#### NOTE:

\*ADAPTOR SET PACKED IN 9579GRY/BRW-RRPW or  
9579GRY/BRW-RCPW and 9579GRY/BRW-LRPW or 9579GRY/BRW-LCPW.

## Step#1

Please insert the RSF armrest to the seat and make sure it is secured in position.

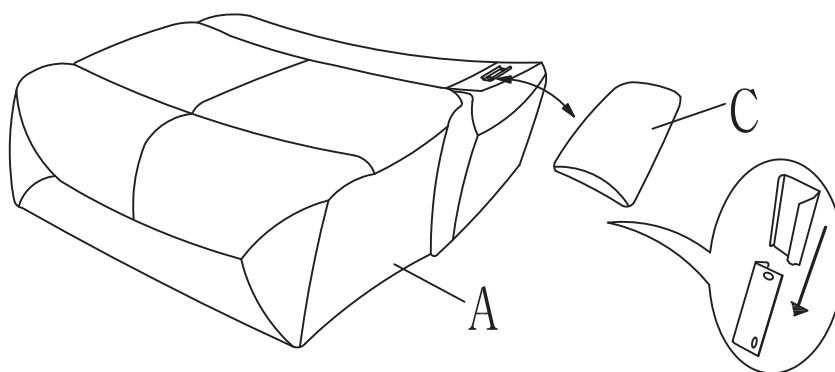

## Step#2

Align the female brackets at the back onto the male brackets at the seat, insert back rest to the seat then push to the end and make sure it is fixed in position securely.

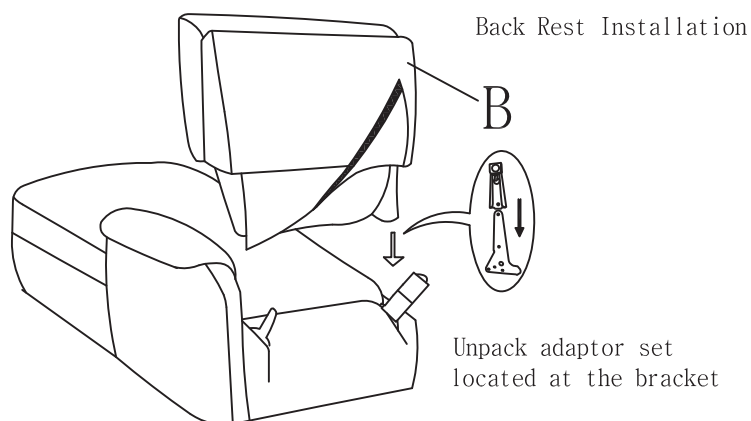

## Step#3

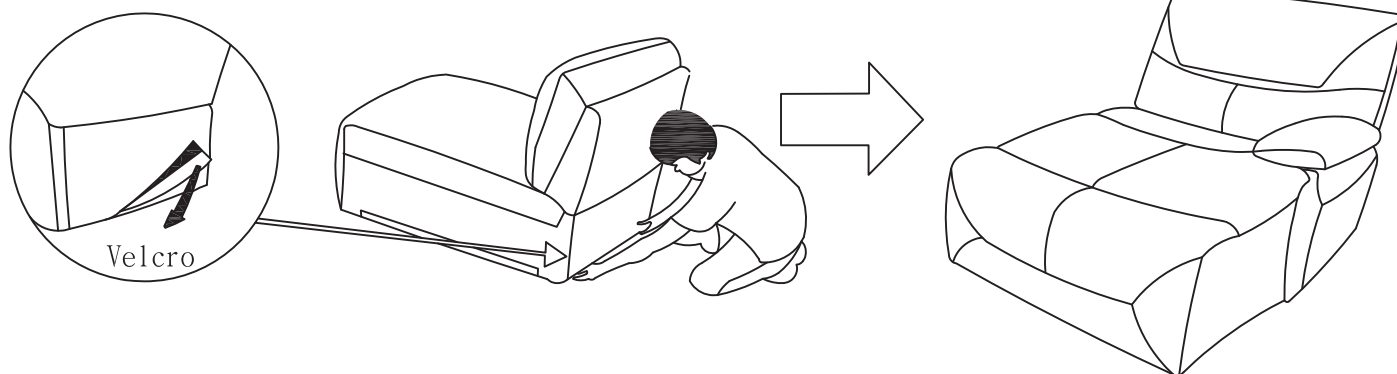

## Step#4

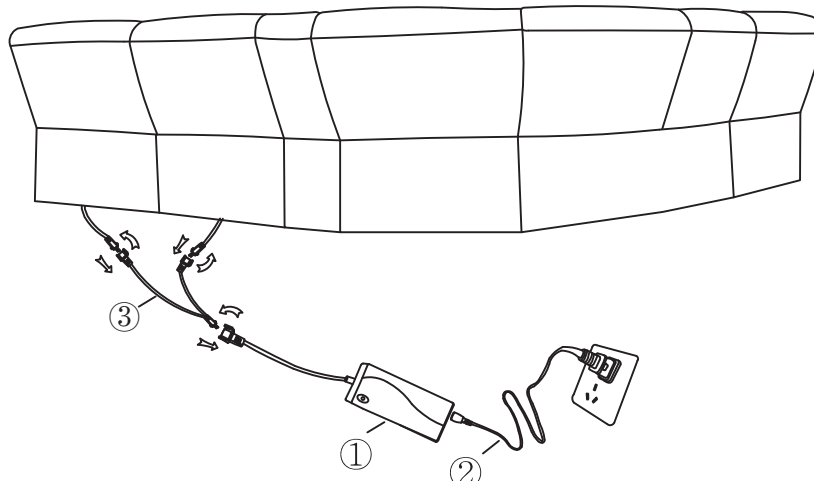

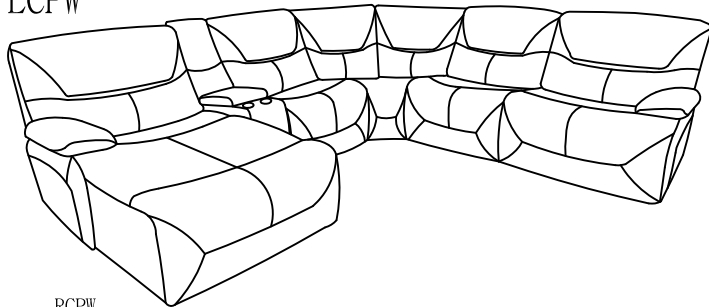
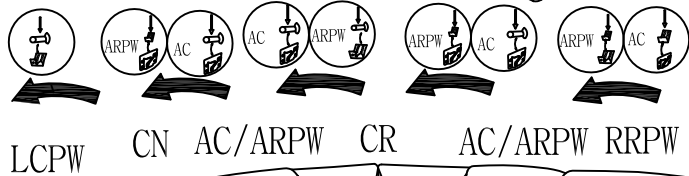
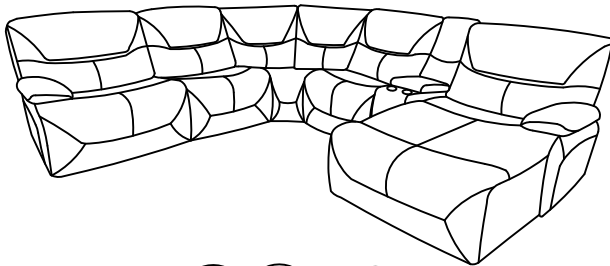
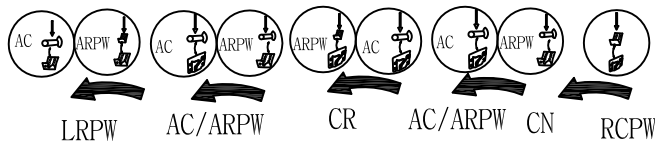

RRPW ⇨ AC

ARPW ⇨ CR

ARPW ⇨ CN

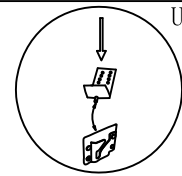

RRPW ⇨ ARPW

ARPW ⇨ LRPW

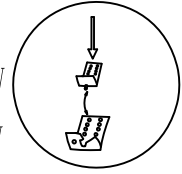

AC ⇨ CR

CN ⇨ AC

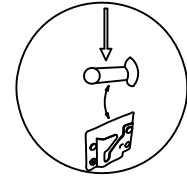

CN ⇨ ARPW

AC ⇨ LRPW

CR ⇨ ARPW

CN ⇨ LCPW

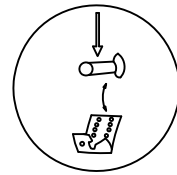

Step#6

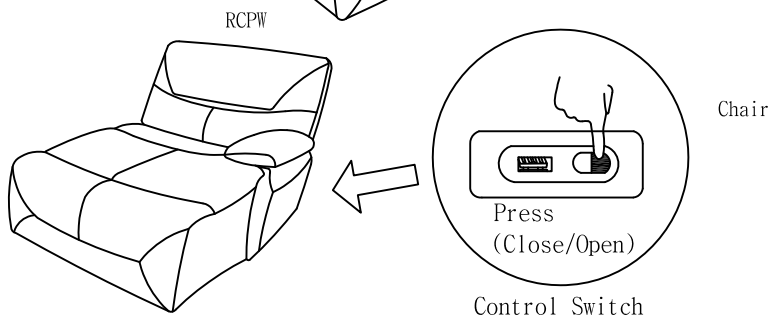

CARE INSTRUCTION FOR LEATHER GEL

In order to maintain the original appearance of your leather gel, please follow below simple care procedure:

- Avoid exposing furniture directly to sunlight or heating and air conditioning outlets. Exposure to sunlight or heating and air conditioning outlets will fade/damage leather gel.
- Wipe gently with a damp soft cloth to remove dust, dirt and any grime build up.



- Disconnect the electrical plug from the wall outlets before cleaning, moving, servicing or when not in use for an extended period of time.
- Plug directly into a wall outlet. Do not use an extension cord or adaptor.
- Check the condition of the power transformers, electrical cords, plugs and connectors monthly. Keep the power adaptor and electrical cords away from heat sources. Never operate the unit with a damaged power adaptor, electrical cord, plug or connector.
- Before moving the product, please disconnect the electrical plug from the wall outlet and secure the mechanism to prevent unexpected opening or movement. Never move the product by the mechanism, legrest, handle, or reclining back.
- Do not attempt to disassemble or service the adaptor or motor. No serviceable parts are inside.
- Do not allow electrical cord to be pinched between moving parts or between the frame and the floor. Do not place cord under carpet or in location where it could become worn.
- Unplug the power cord immediately if you detect strange odors or fumes coming from the chair.

PLEASE KEEP ASSEMBLY INSTRUCTION FOR FUTURE REFERENCE