

# Assembly Instruction

## ARMLESS CHAIR

### ITEM NO.9579GRY-AC

NOTE:Do not use power tools for assembly. Power tools increase the risk of over tightening which lead to splitting or cracking the wood.

#### COMPONENT LIST

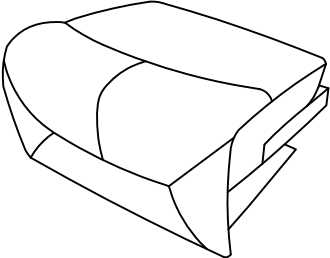
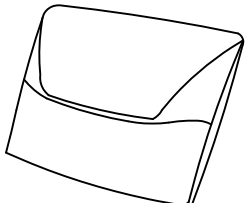
NO.	DRAWING	QTY	DESCRIPTION
A		1PC	SEAT
B		1PC	BACK REST

#### Step#1

Align the female brackets at the back onto the male brackets at the seat, insert back rest to the seat then push to the end and make sure it is fixed in position securely.

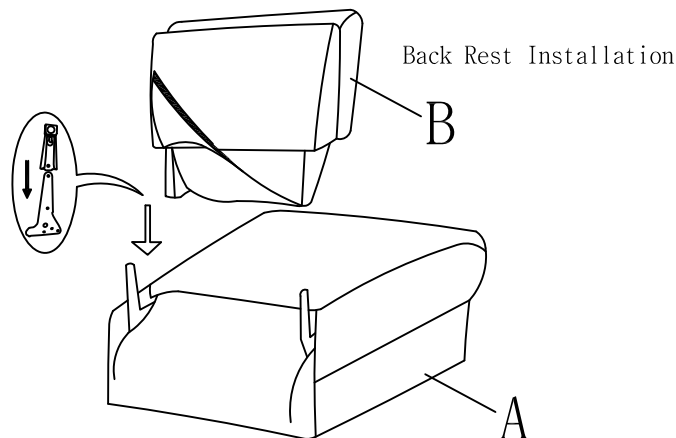

Step#2

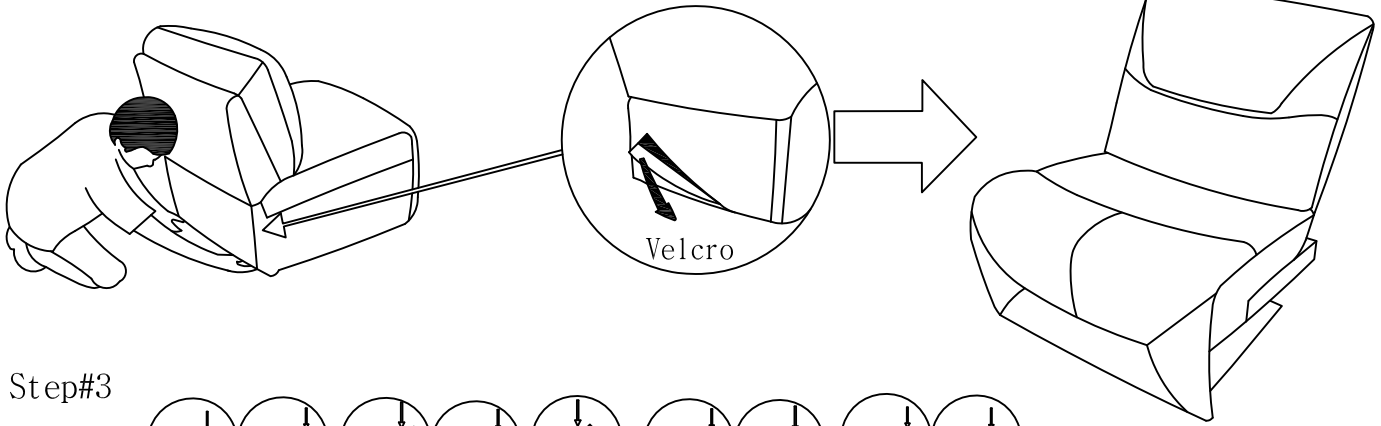

Step#3

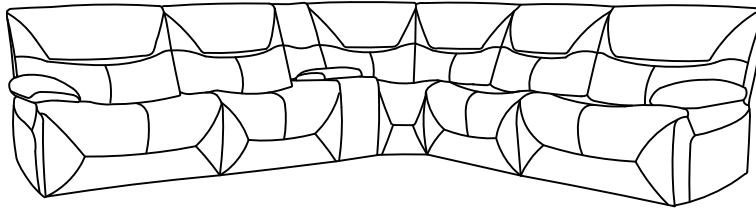
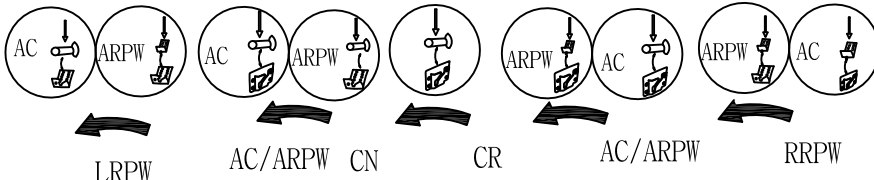

- RRPW ⇒ AC
- ARPW ⇒ CR
- ARPW ⇒ CN
- RCPW ⇒ CN

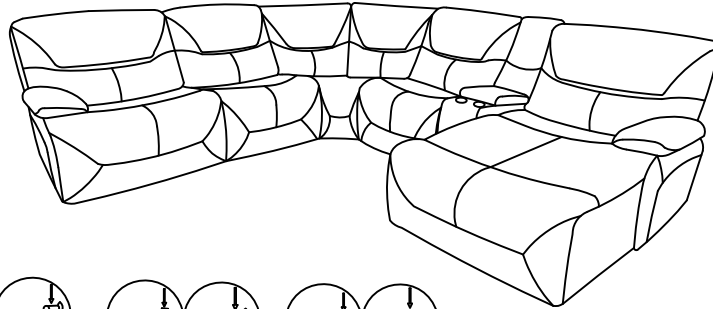
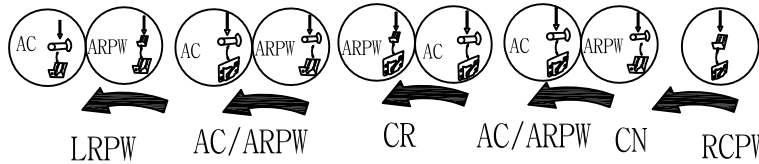
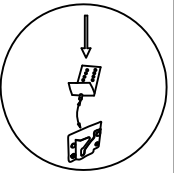

- RRPW ⇒ ARPW
- ARPW ⇒ LRPW

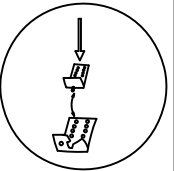

- AC ⇒ CR
- CR ⇒ CN
- CN ⇒ AC

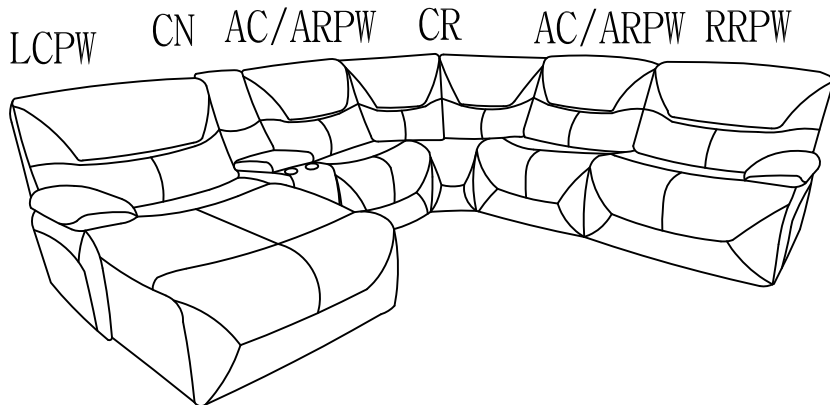
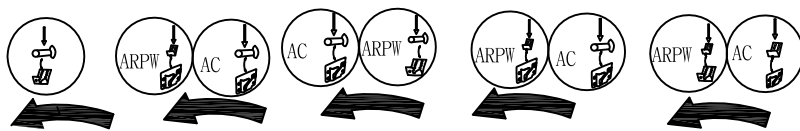
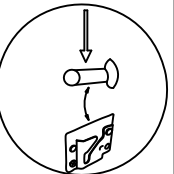

- CN ⇒ ARPW
- AC ⇒ LRPW
- CR ⇒ ARPW
- CN ⇒ LCPW

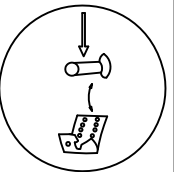

CARE INSTRUCTION FOR LEATHER GEL

In order to maintain the original appearance of your leather gel, please follow below simple care procedure:

- Avoid exposing furniture directly to sunlight or heating and air conditioning outlets. Exposure to sunlight or heating and air conditioning outlets will fade/damage leather gel.
- Wipe gently with a damp soft cloth to remove dust, dirt and any grime build up.