



Assembly Instruction

ITEM NO.9538GY/RN-2





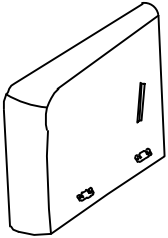
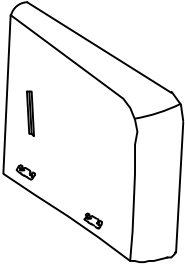
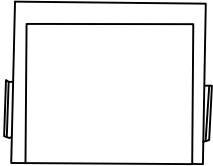
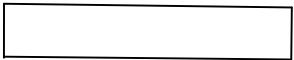

LOVE SEAT

NOTE:Do not use power tools for assembly.Power tools increase the risk of over tightening which lead to splitting or cracking the wood.

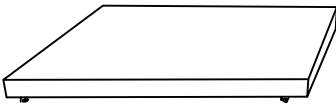
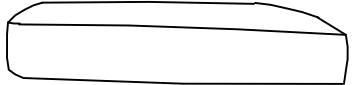
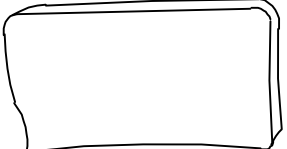
PARTS LIST

NO.	DRAWING	QTY	DESCRIPTION
A		1	LSF ARM
B		1	RSF ARM
C		1	BACK REST
D		1	FRONT PANEL

PARTS LIST

NO.	DRAWING	QTY	DESCRIPTION
E		1	SEAT FRAME
F		2	SEAT CUSHION
G		2	BACK CUSHION
H		4	WASHER
I		4	PLASTIC LEG
J		1	ALLEN KEY 1-1/10"*2-9/10"
K		4	BOLT M8*35
L		1	CENTER SUPPORT PLASTIC LEG

Please follow the drawings below to assemble the item

Legs and hardware are put in the carton, please take out for assembly

Step 1:

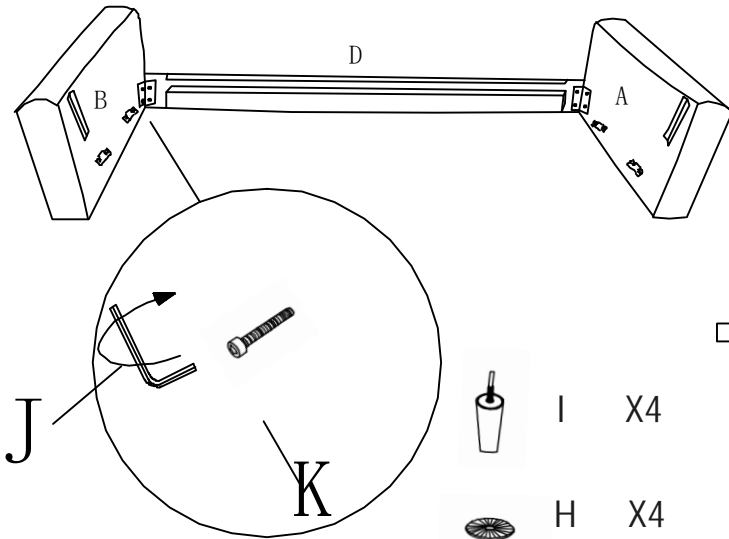

Step 2:

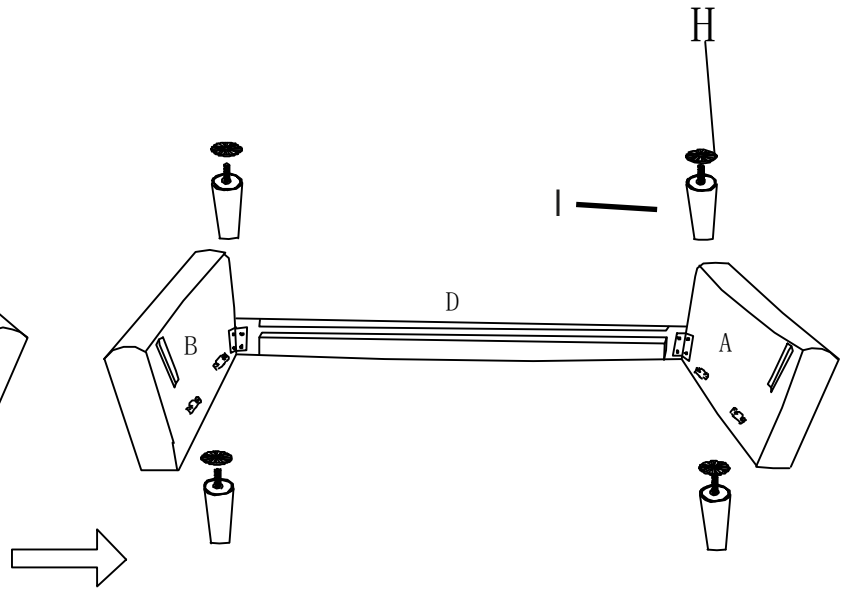

Step 3:

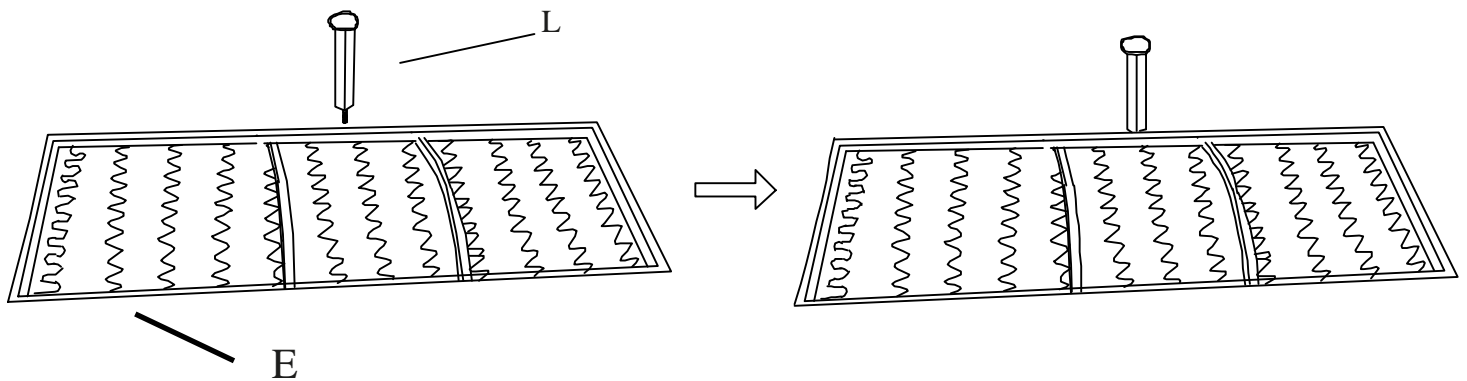

Step 4:

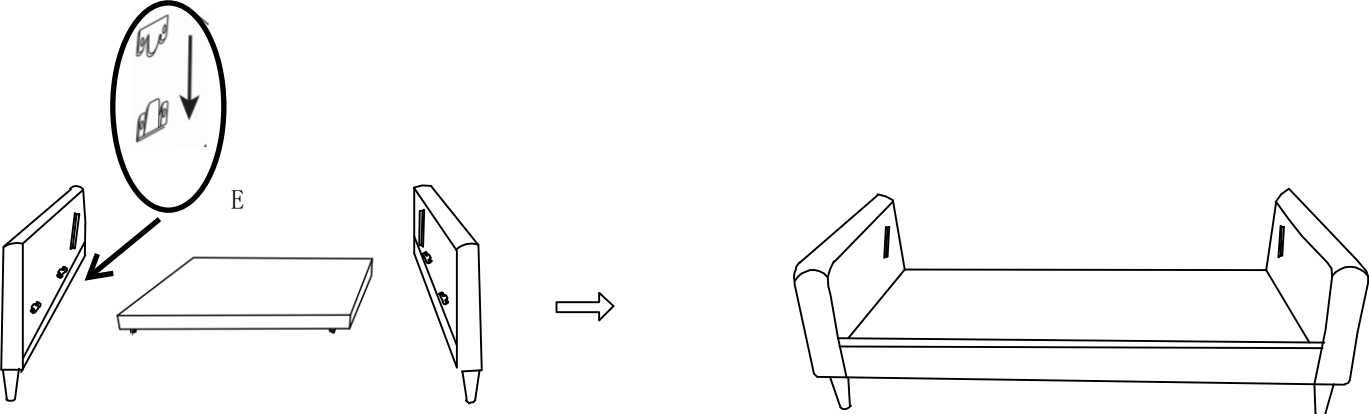

Step 5:

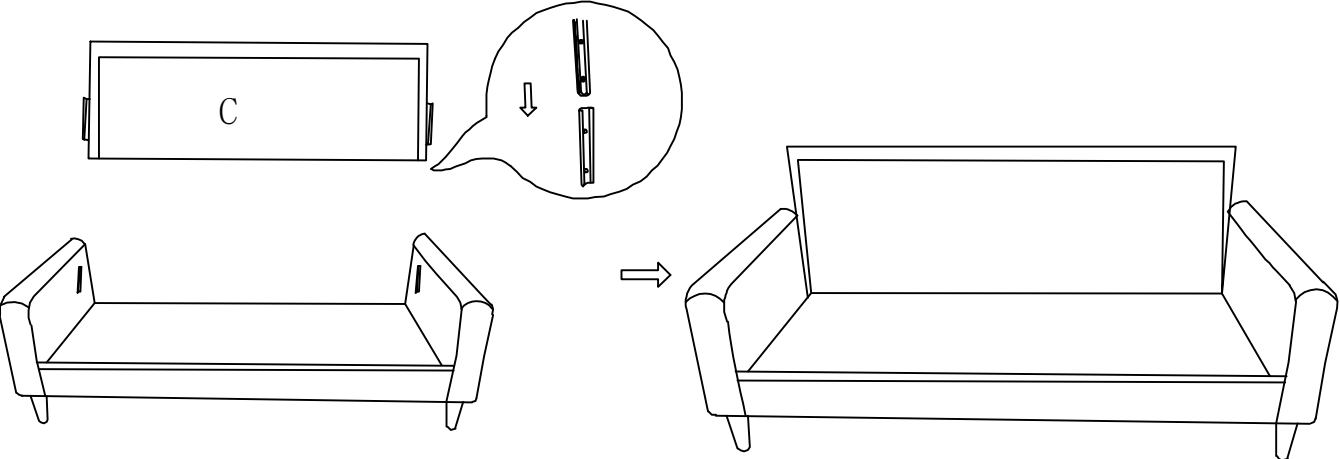

Step 6:

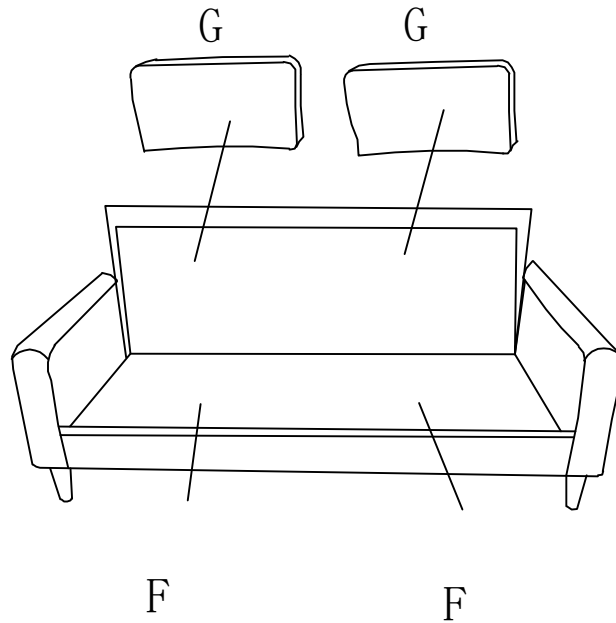

Step 7: Completed

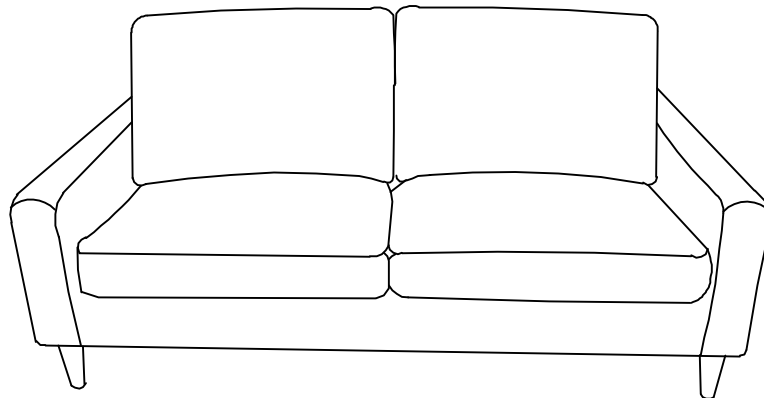

CARE INSTRUCTION FOR 100% POLYESTER FURNITURE

- Avoid exposing furniture directly to sunlight or heating and air conditioning outlets. Exposure to sunlight or heating and air conditioning outlets will fade/damage 100% polyester.
- Wipe gently with a damp soft cloth to remove dust, dirt and any grime buildup.



For items use on wooden floor, hard surfaces or carpets, it is recommended to Install protective pads under all legs and supports to avoid/prevent from damages/scratches and discoloration.