



Assembly Instruction

ITEM NO.9538GY/RN-1





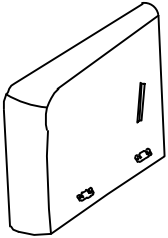
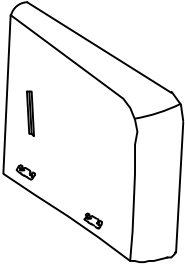
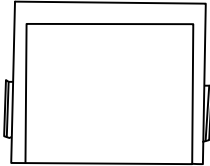
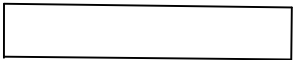

CHAIR

NOTE:Do not use power tools for assembly.Power tools increase the risk of over tightening which lead to splitting or cracking the wood.

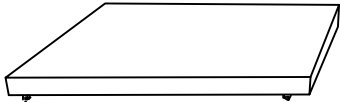
PARTS LIST

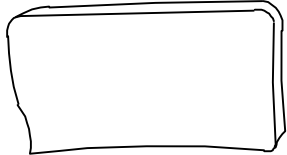
NO.	DRAWING	QTY	DESCRIPTION
A		1	LSF ARM
B		1	RSF ARM
C		1	BACK REST
D		1	FRONT PANEL

PARTS LIST

NO.	DRAWING	QTY	DESCRIPTION
E		1	SEAT FRAME
F		1	SEAT CUSHION
G		1	BACK CUSHION
H		4	WASHER
I		4	PLASTIC LEG
J		1	ALLEN KEY 1-1/10"*2-9/10"
K		4	BOLT M8*35

Please follow the drawings below to assemble the item.

Legs and hardware are put in the carton, please take out for assembly

Step 1:

Step 2:

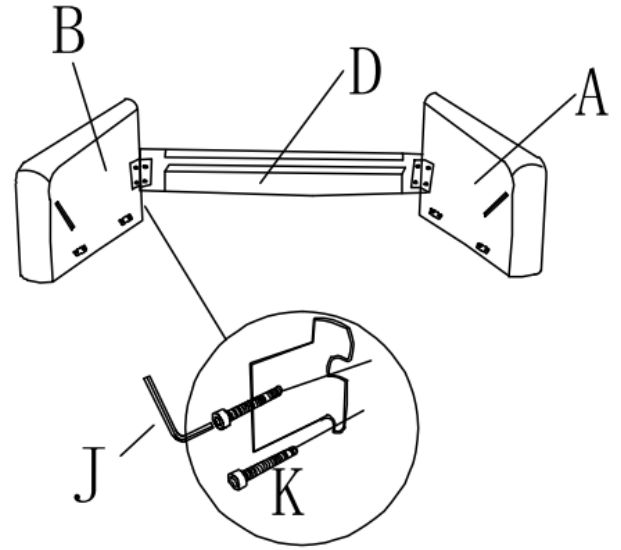
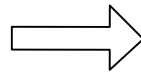
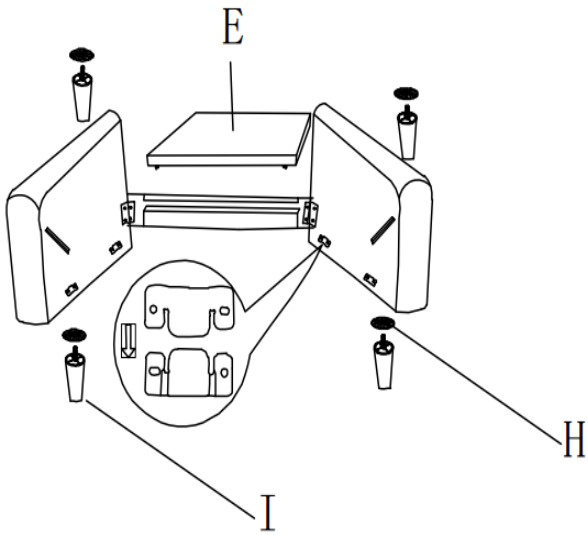

Step 3:

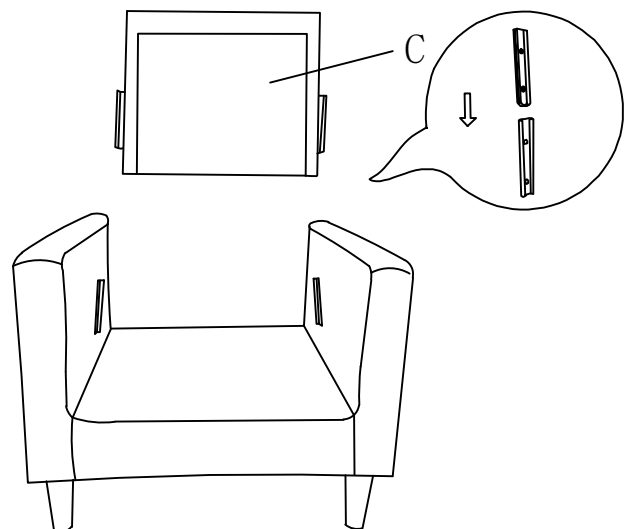
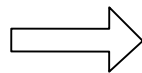
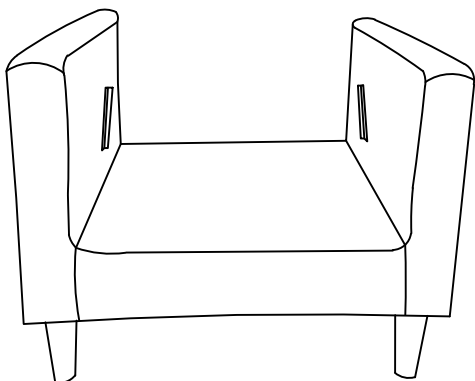

Step 4:

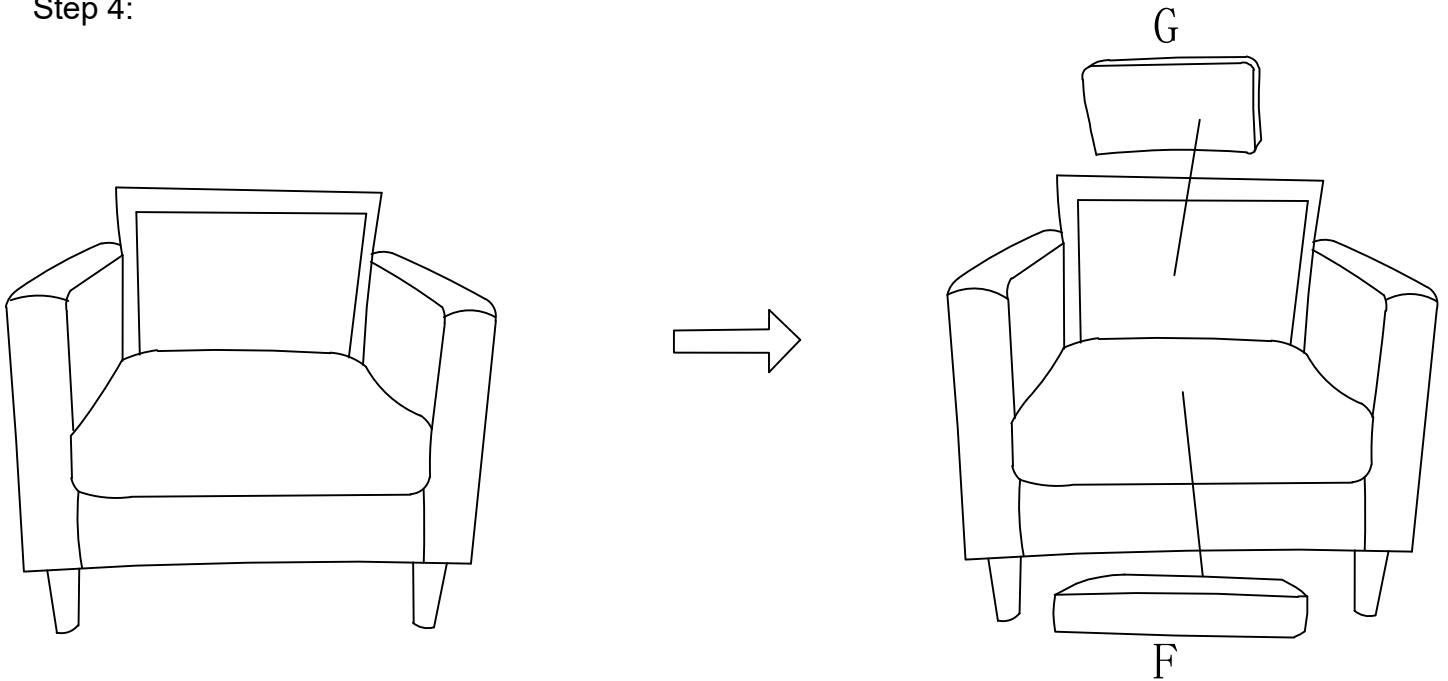

Step 5: Completed

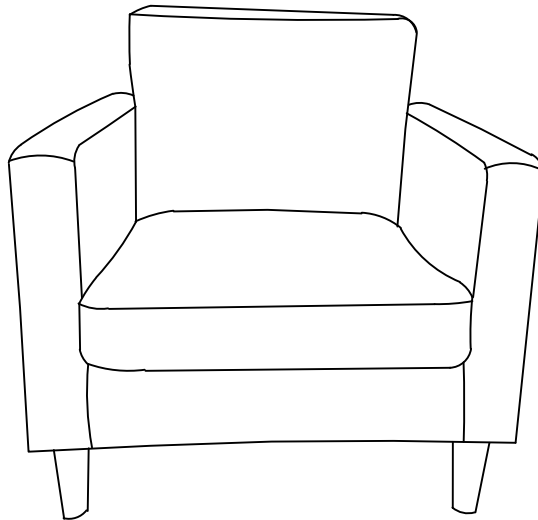

CARE INSTRUCTION FOR 100% POLYESTER FURNITURE

- Avoid exposing furniture directly to sunlight or heating and air conditioning outlets. Exposure to sunlight or heating and air conditioning outlets will fade/damage 100% polyester.
- Wipe gently with a damp soft cloth to remove dust, dirt and any grime buildup.
- ⚠ For items use on wooden floor, hard surfaces or carpets, it is recommended to Install protective pads under all legs and supports to avoid/prevent from damages/scratches and discoloration.