

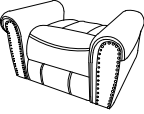



# ASSEMBLING INSTRUCTIONS

ITEM NO: 9467BR-1 Glider Reclining Chair

•NOTE: Do not use power tools for assembly. Power tools increase the risk of over tightening which lead to splitting or cracking the wood.

## COMPONENT LIST

NO.	DRAWING	QTY	DESCRIPTION
A		1 PC	SEAT
B		1 PC	BACK REST
C		1 PC	LSF EAR
D		1 PC	RSF EAR

### STEP 1:

Attach Back Rest (B) to the Seat (A).

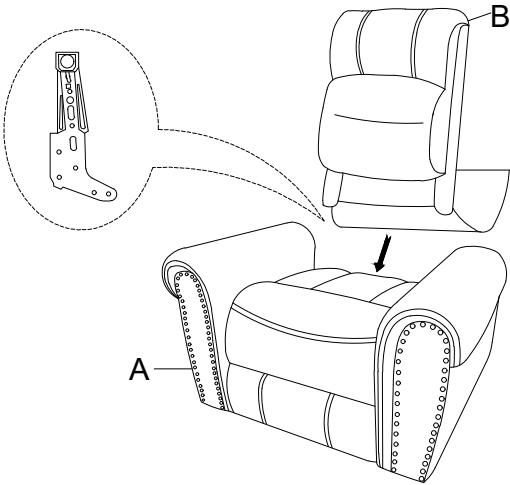

### STEP 2:

Attach the LSF Ear (C) and RSF Ear (D) to the Back Rest (B).

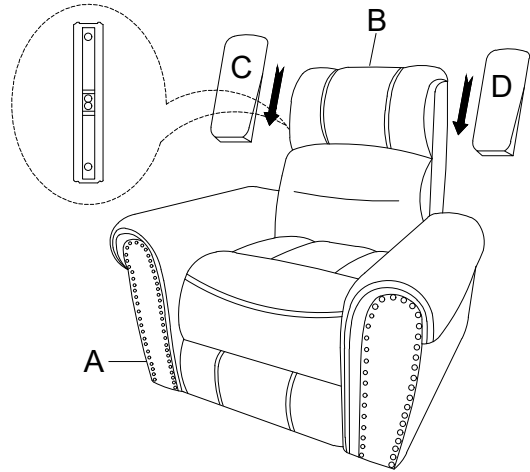

### STEP 3:

Completed

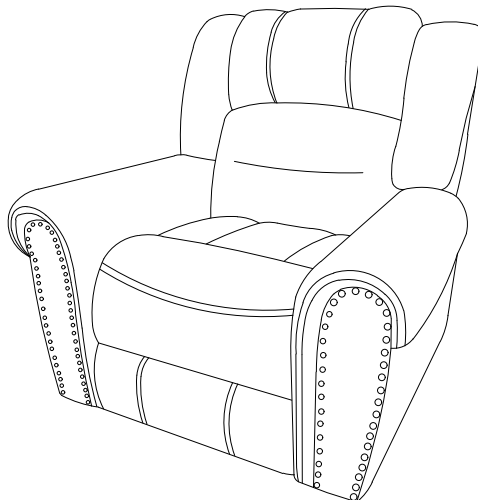

# ASSEMBLING INSTRUCTIONS

ITEM NO: 9467BR-1 Glider Reclining Chair

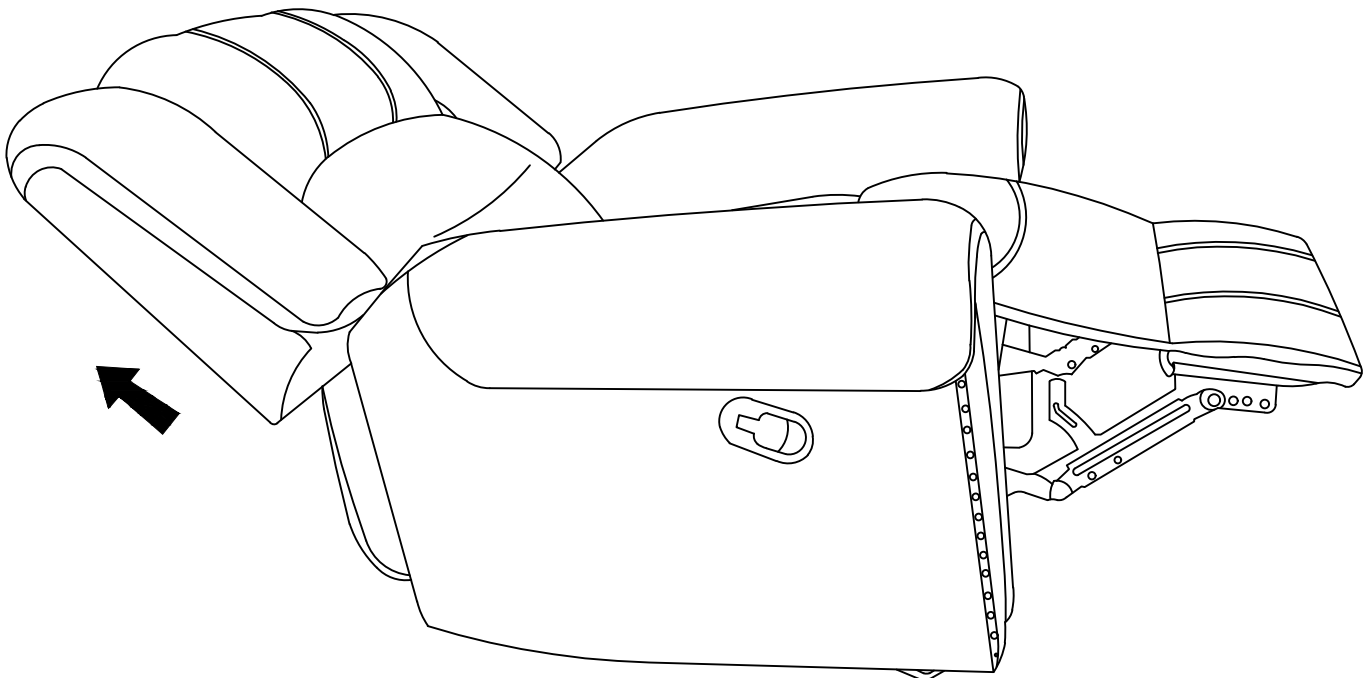
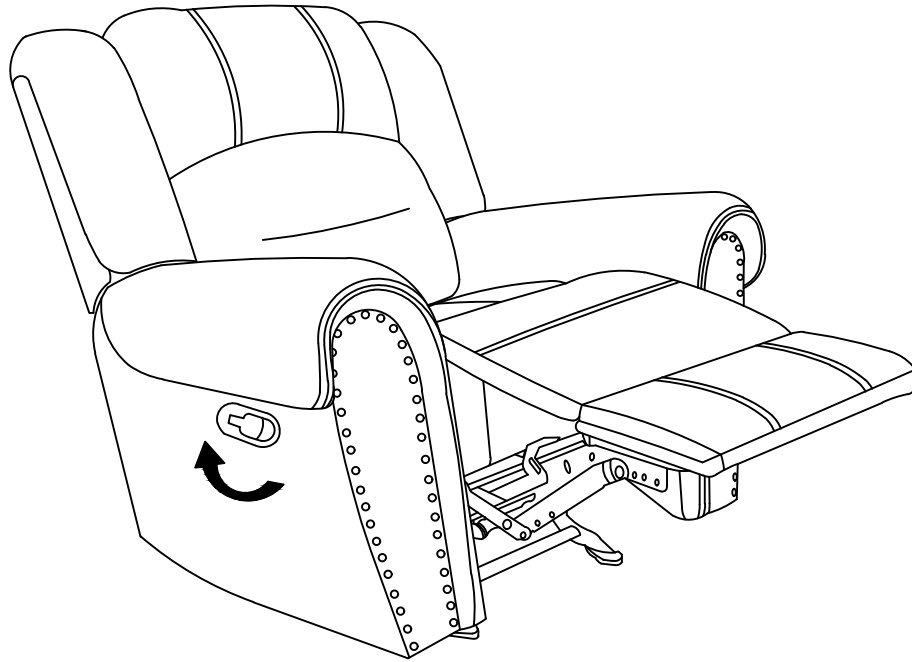

## CARE INTRUCTION FOR 100% POLYESTER FURNITURE.

In order to maintain the original appearance of your 100% polyester furniture, please follow below care procedures.

- Avoid exposing furniture directly to sunlight or heating and air conditioning outlets. Sunlight and or exposure to heading and air conditioning outlets will fade/damage fabric.
- Do not place your upholstered furniture too close to windows, radiators, or vents and be sure to use window, radiators, or vents.
- Vacuum or wipe with a cloth regularly to remove dust.



For items used on wooden floor, hard surfaces or carpets, it is recommended to install protecve pads under all legs supports to avoid/prevent from damages/scratches discoloration.