



# Assembly Instruction

## RSF POWER RECLINING CHAIR WITH POWER HEADREST & USB PORT



ITEM NO.9429TP-RRPWH

NOTE: Do not use power tools for assembly. Power tools increase the risk of over tightening which lead to splitting or cracking the wood.

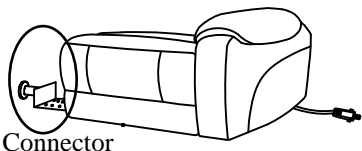
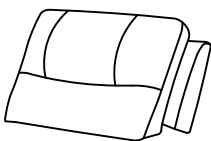
### COMPONENT LIST (CHAIR)

| NO. | DRAWING   | QTY | DESCRIPTION    |
|-----|---|-----|----------------|
| A   |   | 1PC | SEAT WITH WIRE |
| B   |  | 1PC | BACK REST      |

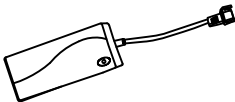
### HARDWARE LIST

| NO. | DRAWING   | QTY | DESCRIPTION    |
|-----|---|-----|----------------|
| 1   |  | 1PC | ADAPTOR        |
| 2   |  | 1PC | PLUG WITH WIRE |

NOTE :

\*ADAPTOR & PLUG WITH WIRE ARE PACKED IN 9429TP-RRPWH AND 9429TP-RCPW.

### Step#1

Align the female brackets at the back onto the male brackets at the seat, insert back rest to the seat then push to the end and make sure it is fixed in position securely. Connecting the wire from back rest to seat for power headrest.

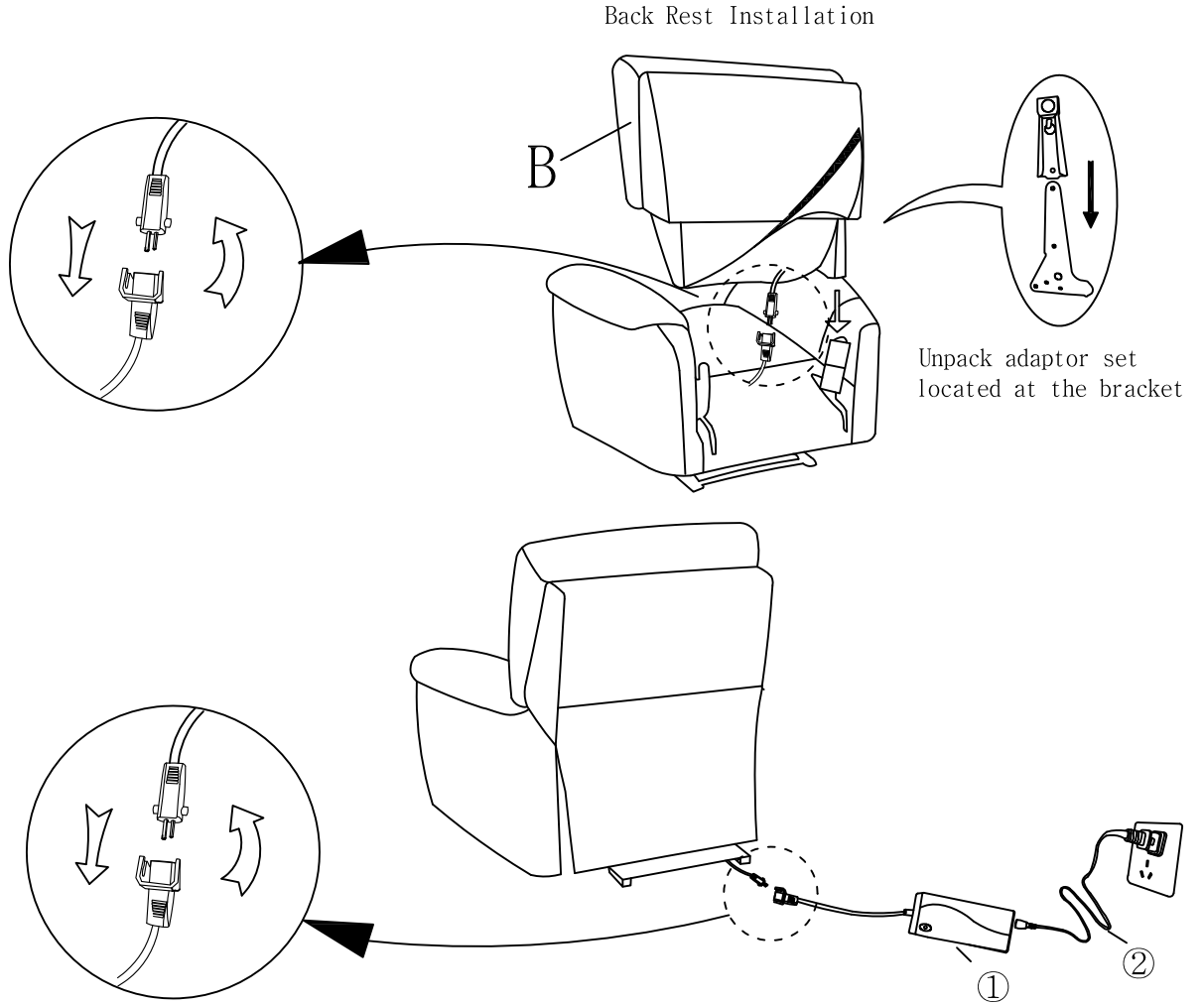

### Step#2

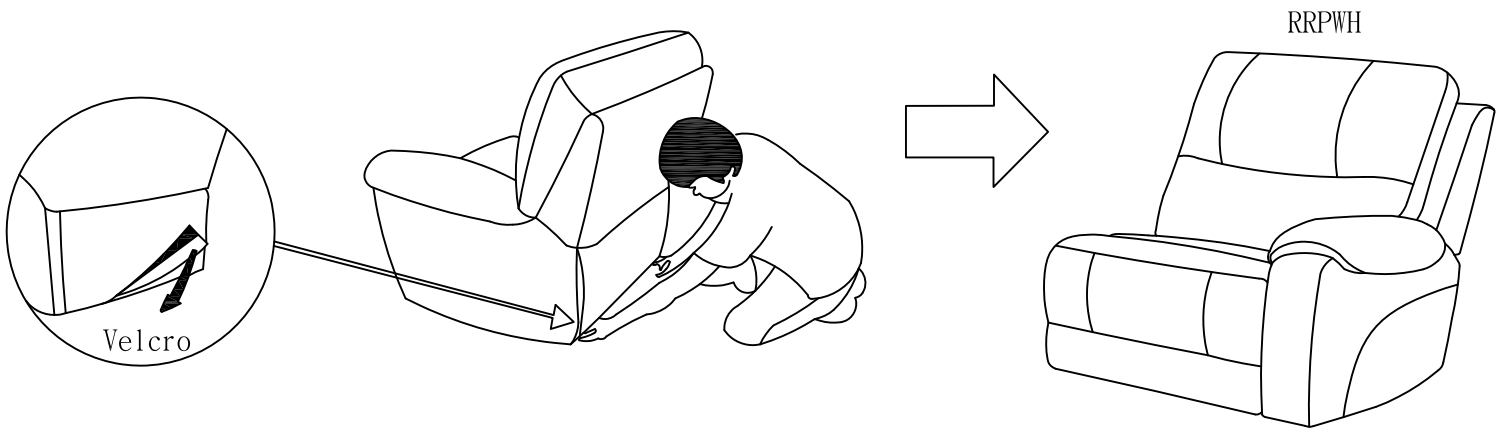

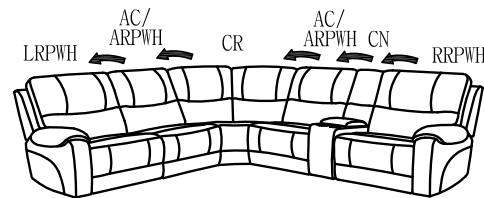

- RRPWH → AC
- ARPWH → CR
- ARPWH → CN
- RCPW → CN

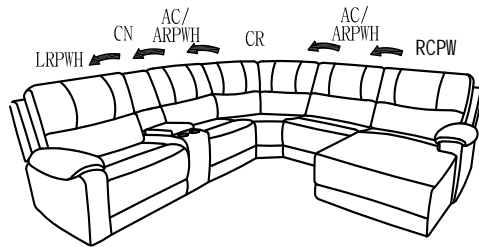
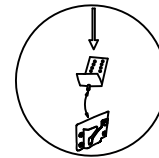

- RRPWH → ARPWH
- ARPWH → LRPWH

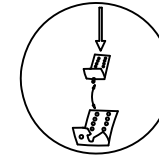

- AC → CR
- CR → CN
- CN → AC

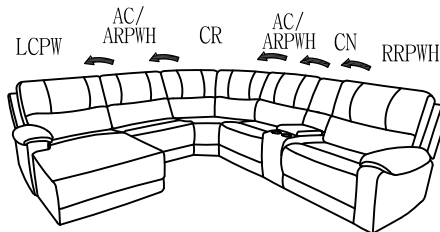
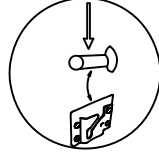

- CN → ARPWH
- AC → LRPWH
- CR → ARPWH
- CN → LCPW

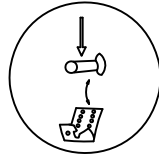

Step#4

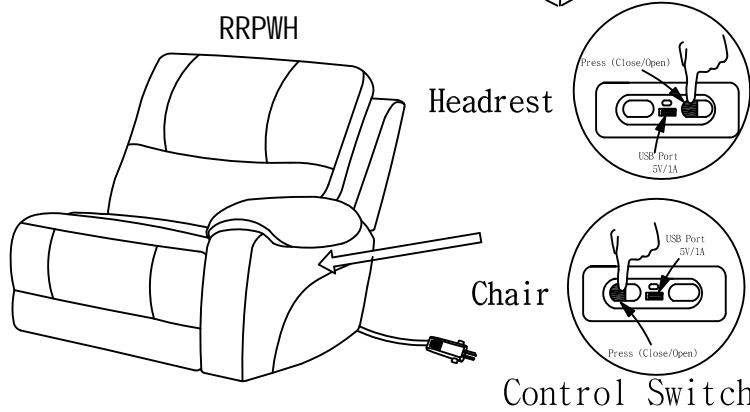

CARE INSTRUCTION FOR POLYESTER

In order to maintain the original appearance of your polyester furniture, please follow below simple care procedure:

- Avoid exposing furniture directly to sunlight or heating and air conditioning outlets. Exposure to sunlight or heating and air conditioning outlets will fade/damage polyester.
- Wipe gently with a damp soft cloth to remove dust dirt and any grime build up.

**! WARNING**

- Disconnect the electrical plug from the wall outlets before cleaning, moving, servicing or when not in use for an extended period of time.
- Plug directly into a wall outlet. Do not use an extension cord or adaptor.
- Check the condition of the power transformers, electrical cords, plugs and connectors monthly. Keep the power adaptor and electrical cords away from heat sources. Never operate the unit with a damaged power adaptor, electrical cord, plug or connector.
- Before moving the product, please disconnect the electrical plug from the wall outlet and secure the mechanism to prevent unexpected opening or movement. Never move the product by the mechanism, legrest, handle, or reclining back.
- Do not attempt to disassemble or service the adaptor or motor. No serviceable parts are inside.
- Do not allow electrical cord to be pinched between moving parts or between the frame and the floor. Do not place cord under carpet or in location where it could become worn.
- Unplug the power cord immediately if you detect strange odors or fumes coming from the chair.