











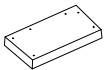

ASSEMBLY INSTRUCTION

ITEM NO: 9367GRY-2N Love seat

 Legs and hardware are stored in the box, please take out for assembly.

NOTE: Do not use power tools for assembly. Power tools increase the risk of over tightening which lead to splitting or cracking the wood.

LOVE SEAT COMPONENT LIST

| NO. | DRAWING | QTY | DESCRIPTION |
|-----|---|-----|--------------------------|
| A |  | 1 | SEAT |
| B |  | 1 | BACK REST |
| C |  | 1 | LSF ARM |
| D |  | 1 | LSF SEAT CUSHION |
| E |  | 1 | RSF SEAT CUSHION |
| F |  | 2 | BACK CUSHION |
| G |  | 4 | PLASTIC LEG 4"* 4"*3.15" |
| H |  | 7 | FLAT WASHER Ø5/16" |
| I |  | 7 | NUT Ø5/16" |
| K |  | 7 | BOLT Ø5/16"*3.6" |
| L |  | 1 | WRENCH |
| M |  | 4 | PLASTIC WASHER Ø1.75" |
| N |  | 1 | RSF ARM |

Step 1

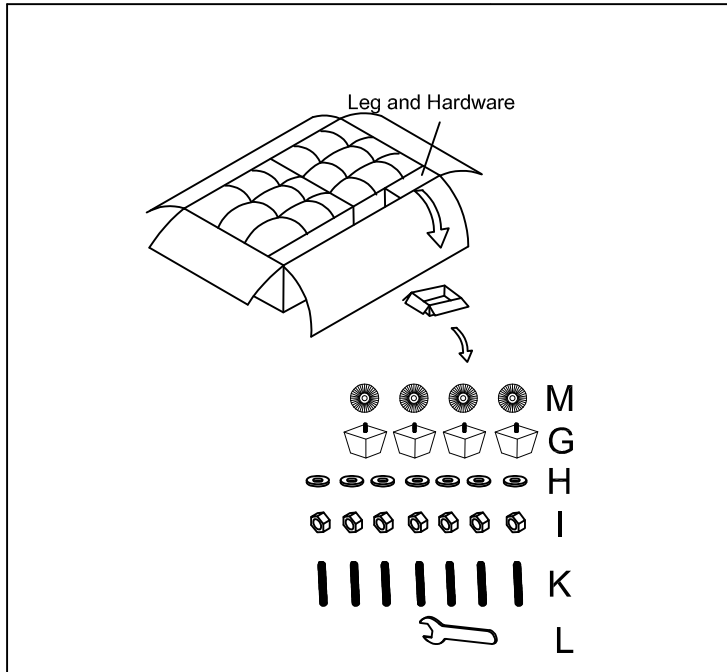

Step 2

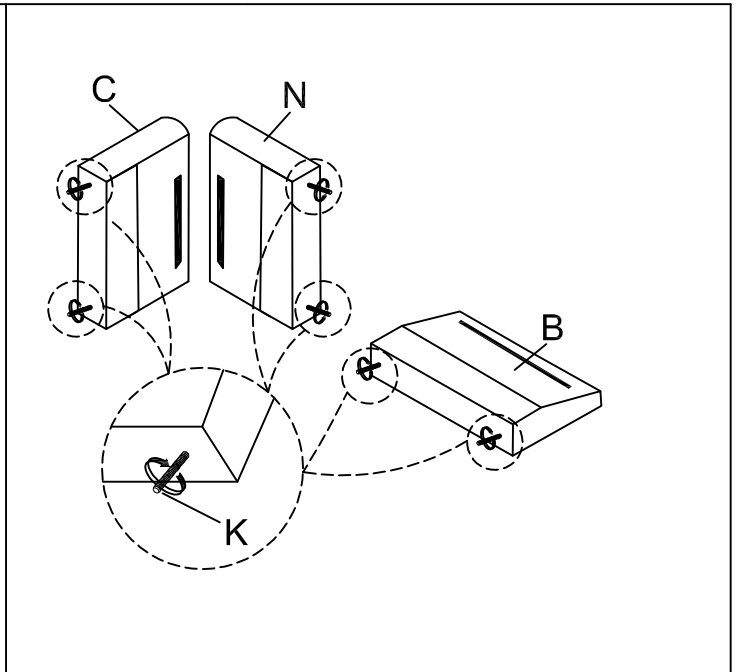

Step 3

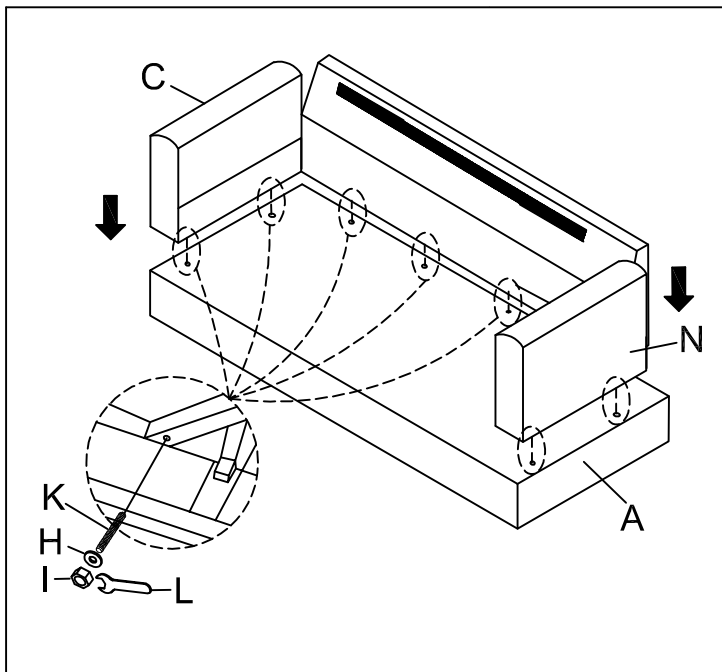

Step 4

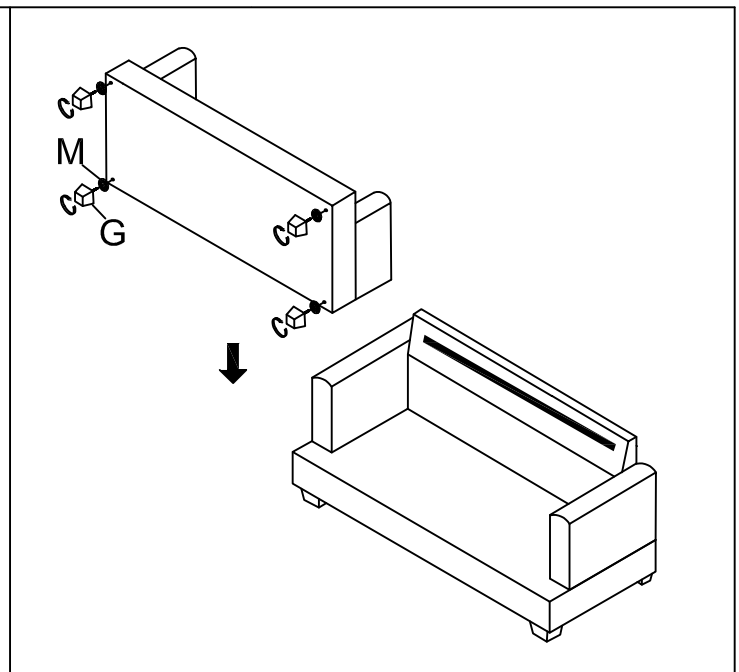

Step 5

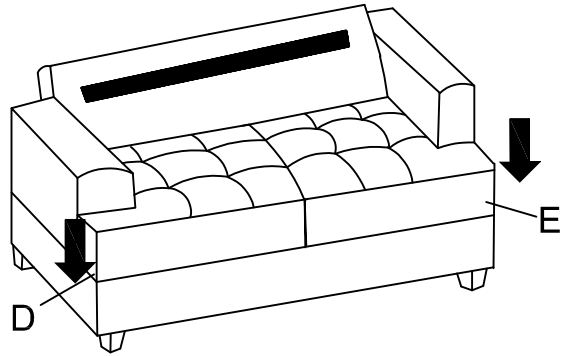

Step 6

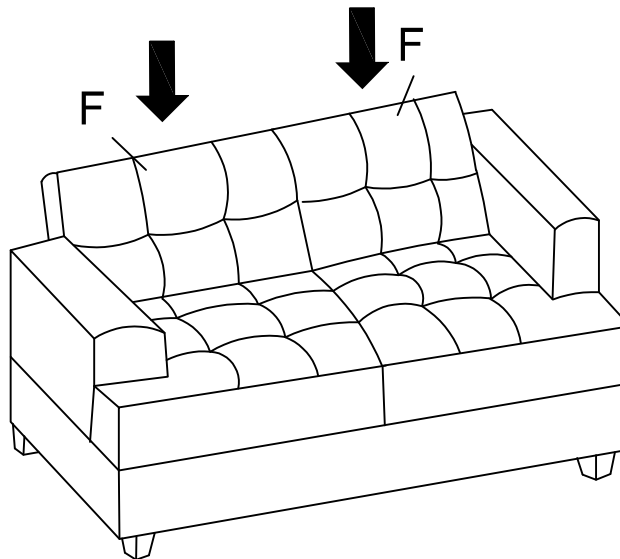

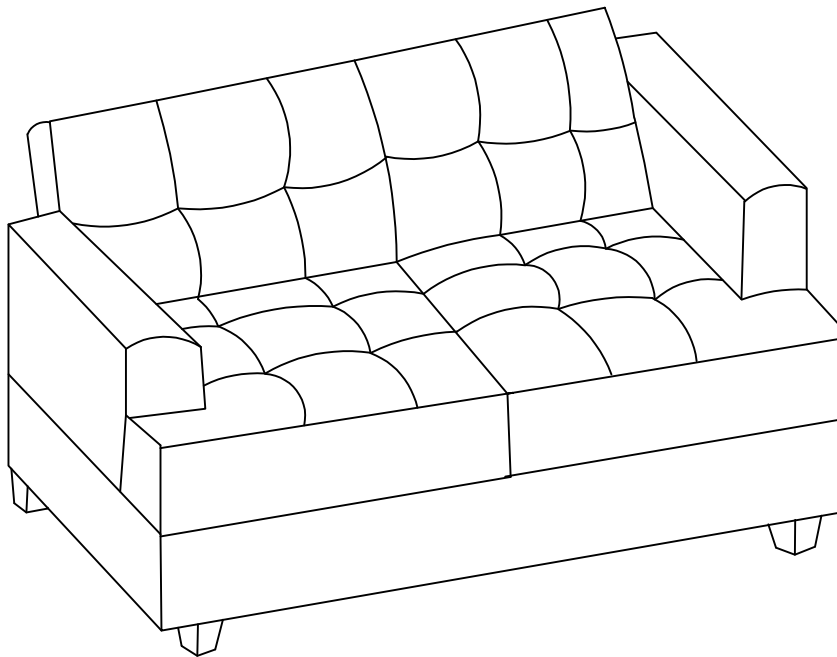

CARE INSTRUCTIONS FOR TEXTURED UPHOLSTERY FURNITURE:

In order to maintain the original appearance of your textured furniture, please follow below care procedures:

- Avoid exposing furniture directly to sunlight or heating and air conditioning outlets. Sunlight and / or exposure to heating and air conditioning outlets will fade/damage textured. Do not place your upholstered furniture too close to windows, radiators, or vents, and be sure to use window treatments to block the sun's rays.
- Vacuum or wipe with a soft cloth regularly to remove dust.



For items use on wooden floor, hard surfaces or carpets, it is recommended to Install protective pads under all legs and supports to avoid/prevent from damages/scratches and discoloration.