

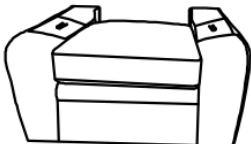



 Legs and hardware are stored in the bubble bag and located underneath the seat, please take out for assembly

Note: Do not use power tools for assembly. Power tools increase the risk of over tightening which lead to splitting or cracking the wood

Component list .

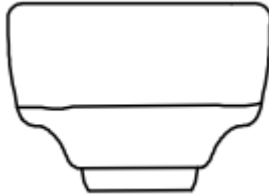
Label	Picture	Description	QTY(pc)
A		SEAT	1
B		LSF ARM	1
C		RSF ARM	1
D		BACK REST	1
E		PLASTIC LEG	4
F		BOLT	4
G		WASHER	4
H		ALLEN KEY	1

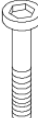
Step #1

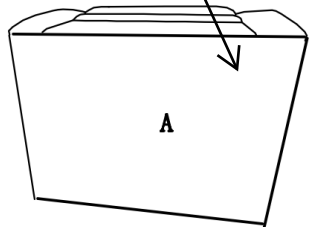
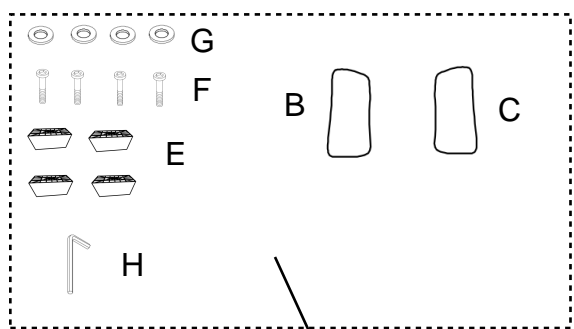

Step #2

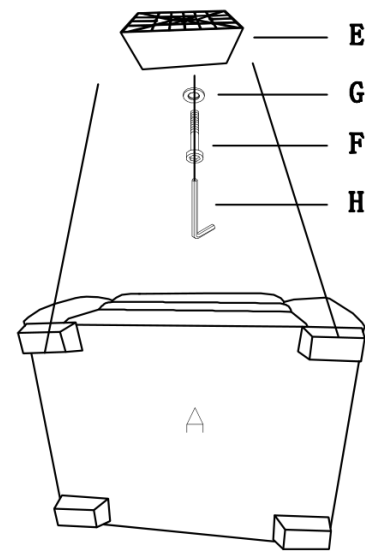

Step #3

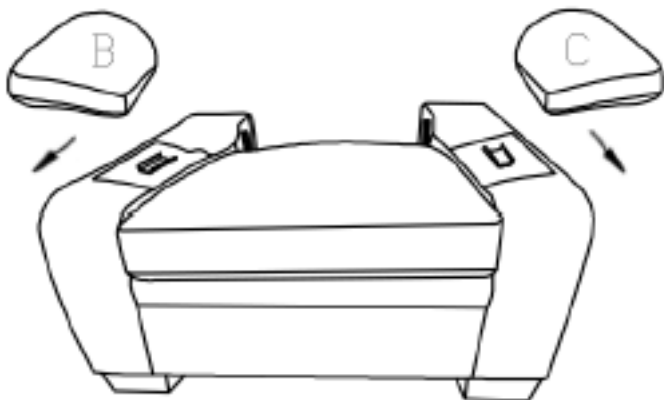

Step #4

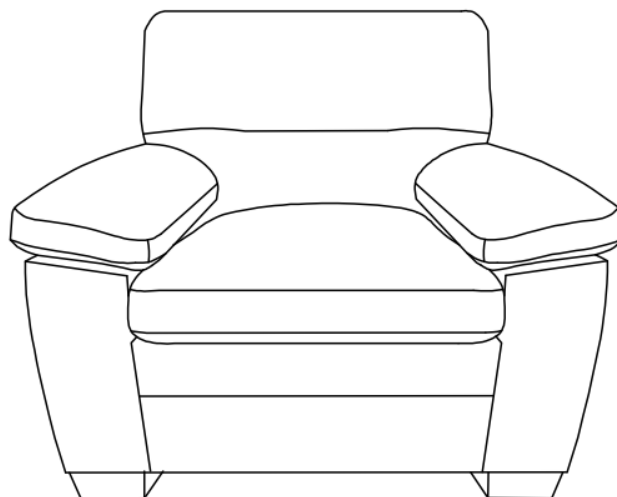
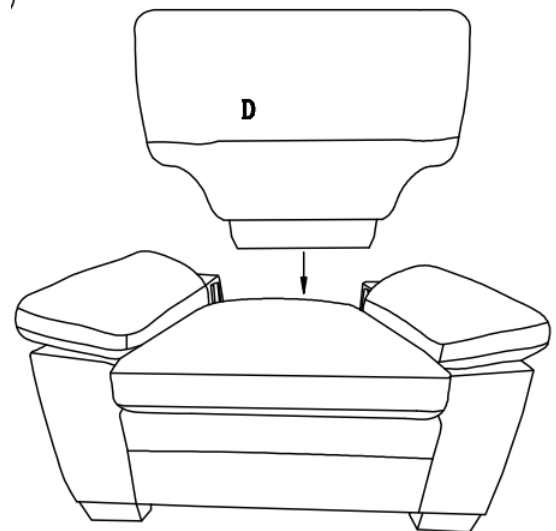

Care Instruction for Textured Fabric Furniture:

In order to maintain the original appearance of your textured fabric furniture, please follow below simple care procedures:

- Avoid exposing furniture directly to sunlight or heating and air conditioning outlets. Sunlight and or exposure to heating and air conditioning outlets will fade/damage textured fabric .
- Vacuum or wipe with a soft cloth to remove dust.



For item use on wooden floor, hard surfaces or carpets, it is recommended to install protective pads under all legs and supports to avoid/prevent from damages/scratches and discoloration.