

Assembly Instruction

ITEM NO.: 8549GRY-2







Double Glider Reclining Love Seat with
Center Console, Receptacles and USB Ports

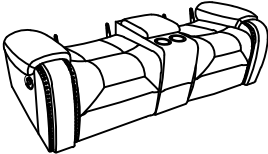

Console Back Rest is stored at the bottom of Love seat, please take out for assembly.

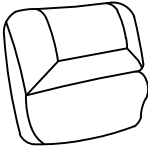
Note: Do not use power tools for assembly. Power tools increase the risk of over tightening which lead to splitting or cracking the wood.

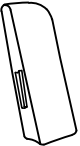
Component list

| No | Drawing | Qty | Description |
|----------|---|----------|--------------------------|
| A |  | 1 | SEAT |
| B |  | 1 | LSF BACK REST |
| C |  | 1 | CONSOLE BACK REST |
| D |  | 1 | RSF BACK REST |
| E |  | 1 | LSF EAR |
| F |  | 1 | RSF EAR |
| G |  | 2 | STAR KNOB |

Step #3

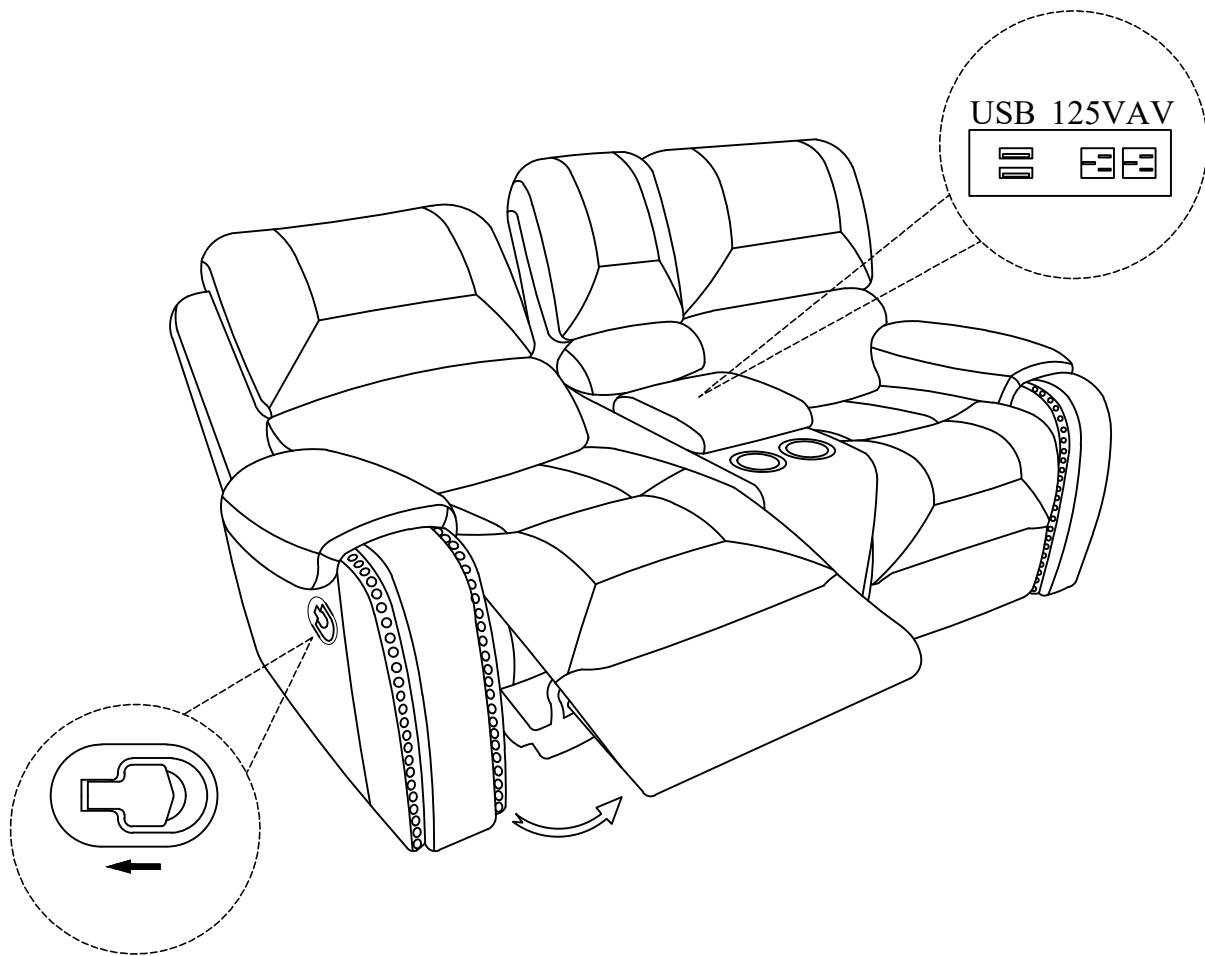

Pull to recline the chair

Care Instruction for Leather Air Furniture:

In order to maintain the original appearance of your Leather Air Furniture, please follow below simple care procedures:

- Avoid exposing furniture directly to sunlight or heating and air conditioning outlets. Sunlight and or exposure to heating and air conditioning outlets will fade/damage Leather Air.
- Vacuum or wipe with a soft cloth to remove dust.
- Hardware may loosen over time. Periodically check to make sure all connection are tight, Re-tighten if necessary



For items use on wooden floor, hard surfaces or carpets, it is recommended to Install protective pads under all legs and supports to avoid/prevent from damages/scratches and discoloration.