







6879WT-01SM SMALL CUBE TABLE, WHITE FAUX MARBLE  
W/NICKEL / PETITE TABLEAU CUBIQUE BLANC

6879BK-01SM SMALL CUBE TABLE, BLACK FAUX MARBLE  
W/GOLD / PETITE TABLEAU CUBIQUE NOIR

## Assembly Instructions / Instructions d'assemblage

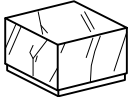
Thank you for purchasing this product from Mazin Furniture. Please take the time to read and follow the instructions below. Check that you have all parts and hardware before assembly. Parts apparently missing are often found in the packing materials. If you do not have all the parts listed, call us and they will be sent to you immediately. Should parts be damaged during transportation, give us a call and we will replace the damaged part as soon as possible.

Merci d'avoir acheté ce produit de Mazin Furniture. Veuillez lire et suivre les instructions ci-dessous. Vérifiez avant le montage que vous avez toutes les pièces et fixations. Les pièces qui semblent manquer se trouvent souvent dans les matériaux d'emballage. Si vous n'avez pas toutes les pièces de la liste, appelez-nous et nous vous les enverrons immédiatement. Si des pièces soient endommagées pendant le transport, appelez-nous et nous remplacerons aussi tôt que possible la pièce endommagée.

PARTS LIST / LISTE DE PIÈCES				HARDWARE LIST / LISTE DE QUINCAILLERIE				
A		TABLE TOP / DESSUS DE LA TABLE	1 PC	1		SCREW / VIS	5/32" x 3/4"	16 PCS
B		CASTER / ROULETTE	2 PCS	2		ELECTRIC DRILL (NOT PROVIDED) / PERCEUSE ÉLECTRIQUE (NON FOURNIE)		
C		CASTER WITH BRAKE / ROULETTE AVEC FREIN	2 PCS					

### STEP 1 / ÉTAPE 1:

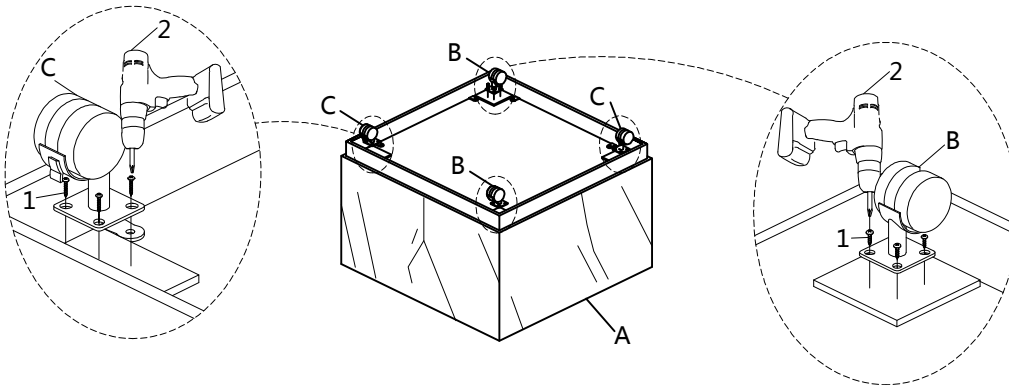

### STEP 2 / ÉTAPE 2:

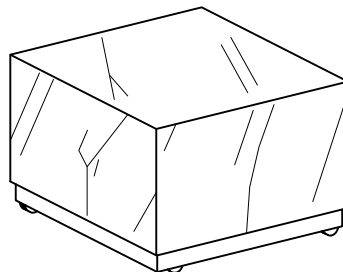

 It is recommended to install protective pads under all legs and supports to avoid damage or scratches when placing furniture on a wood floor or other hard surface, and to limit indentation and prevent discoloration if placing on carpet.

 Il est recommandé de placer des coussins protecteurs sous tous les pieds et toutes les bases des meubles pour éviter d'endommager ou d'égratigner les planchers en bois ou autres surfaces dures, et pour limiter l'empreinte et empêcher la décoloration quand les meubles reposent sur la moquette.