





# ASSEMBLY INSTRUCTION INSTRUCTION D' ASSEMBLAGE

ITEM NO: 5962-96  
DINING TABLE / TABLE DE SALLE À MANGER

Thank you for purchasing this product. Please take time to read and follow the instructions below. Check that you have all parts and hardware before assembly. Parts apparently missing are often found in packing materials. If you do not have all the parts listed, have your dealer contact us and they will be sent to you immediately.

Merci d'avoir acheté ce produit. Veuillez lire et suivre les instructions ci-dessous. Vérifiez avant le montage que vous avez toutes les pièces et fixation. Les pièces qui semblent manquer se trouvent souvent dans les matériaux d'emballage. Si vous n'avez pas toutes les pièces de la liste, demandez à votre détaillant et nous les enverrons immédiatement.



 It is recommended to install protective pads under all legs and supports to avoid damage or scratches when placing furniture on a wood floor or other hard surface, and to limit indentation and prevent discoloration if placing on carpet.

 Il est recommandé de placer des coussins protecteurs sous tous les pieds et toutes les bases des meubles pour éviter d'endommager ou d'égratigner les planchers en bois ou autres surfaces dures, et pour limiter l'empreinte et empêcher la décoloration quand les meubles reposent sur la moquette.



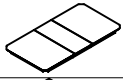

 Hardware may loosen over time. Periodically check to make sure all connections are tight. Re-tighten if necessary.

 Le matériel peut se desserrer au fil du temps. Vérifiez périodiquement que toutes les connexions sont serrées. Serrer à nouveau si nécessaire.

## PART LIST/LISTE DE PIÈCES

NO.	SKETCH/ ESQUISSE	DESCRIPTION/ LA DESCRIPTION	Q'TY/ Q'TÉ
A		TABLE TOP / DESSUS DE TABLE	1 PC
B		TABLE LEAF / DESSUS DE TABLE	1 PC
C		LEGS / PIED	4 PCS

## HARDWARE LIST/LISTE DE QUINCAILLERIE

NO.	DESCRIPTION / LA DESCRIPTION	SIZE / TAILLE	SKETCH / ESQUISSE	Q'TY/ Q'TÉ
1	BOLT / BOULON	Ø5/16" x 2-3/8"		8 PCS
2	LOCK WASHER / RONDELLE D'ARRÊT	Ø5/16" x 1/2"		8 PCS
3	FLAT WASHER / RONDELLE PLATE	Ø5/16" x 3/4"		8 PCS
4	ALLEN KEY / CLÈ ALLEN	1/6" x 2-1/4"		1 PC

## Step 1/ Étape 1

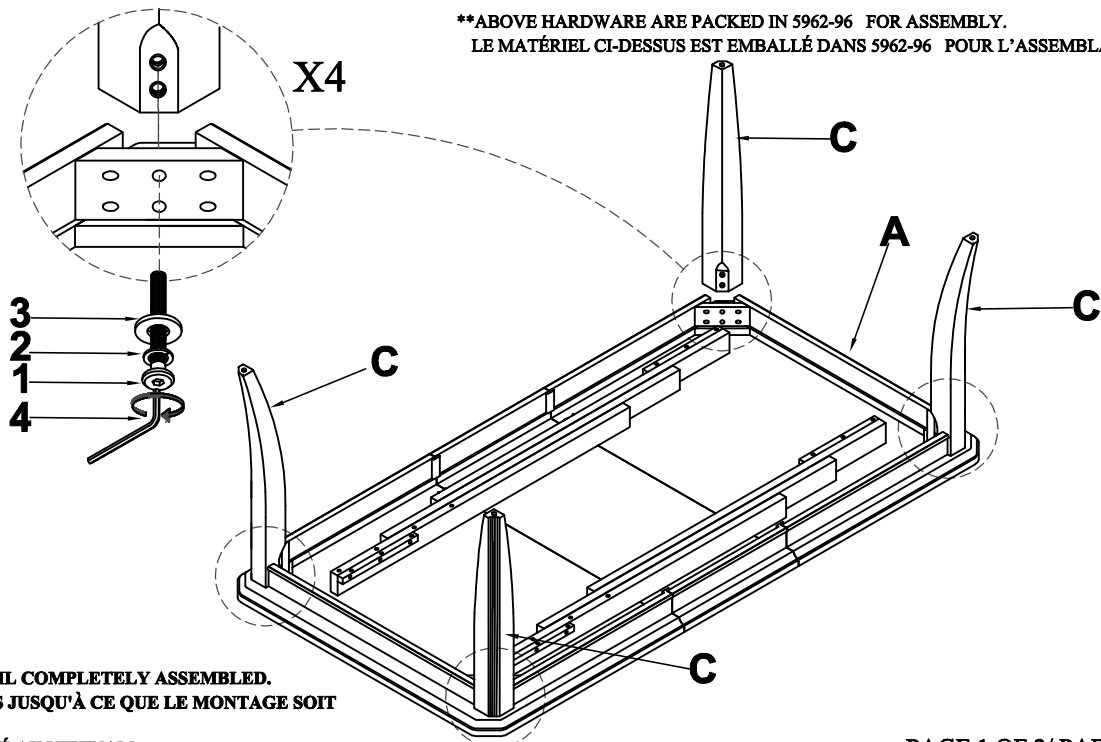

\*\*ABOVE HARDWARE ARE PACKED IN 5962-96 FOR ASSEMBLY.  
LE MATÉRIEL CI-DESSUS EST EMBALLÉ DANS 5962-96 POUR L'ASSEMBLAGE

DO NOT TIGHTEN BOLTS UNTIL COMPLETELY ASSEMBLED.  
NE PAS SERRER LES BOULONS JUSQU'À CE QUE LE MONTAGE SOIT  
COMPLÈTMENT TERMINÉ  
MADE IN VIETNAM / FABRIQUÉ AU VIETNAM

**Step 2/  
Étape 2**

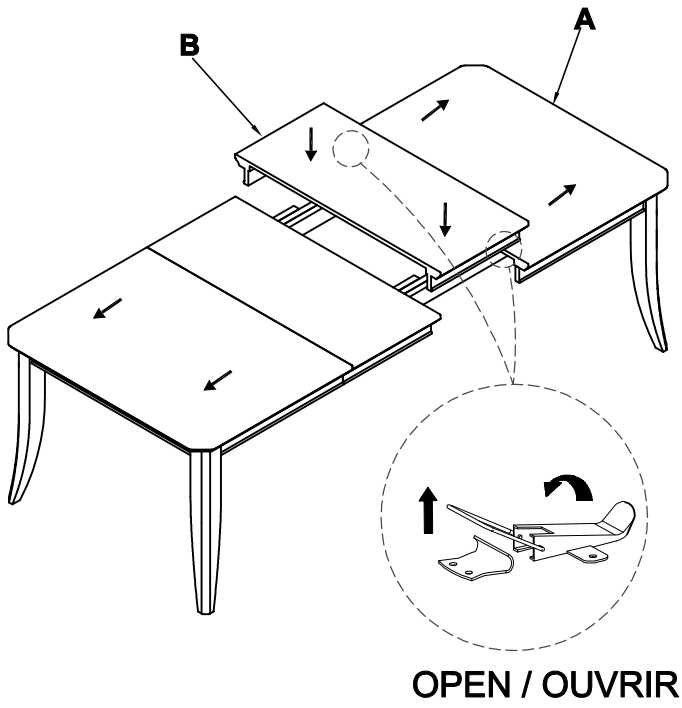

**Step 3/  
Étape 3**

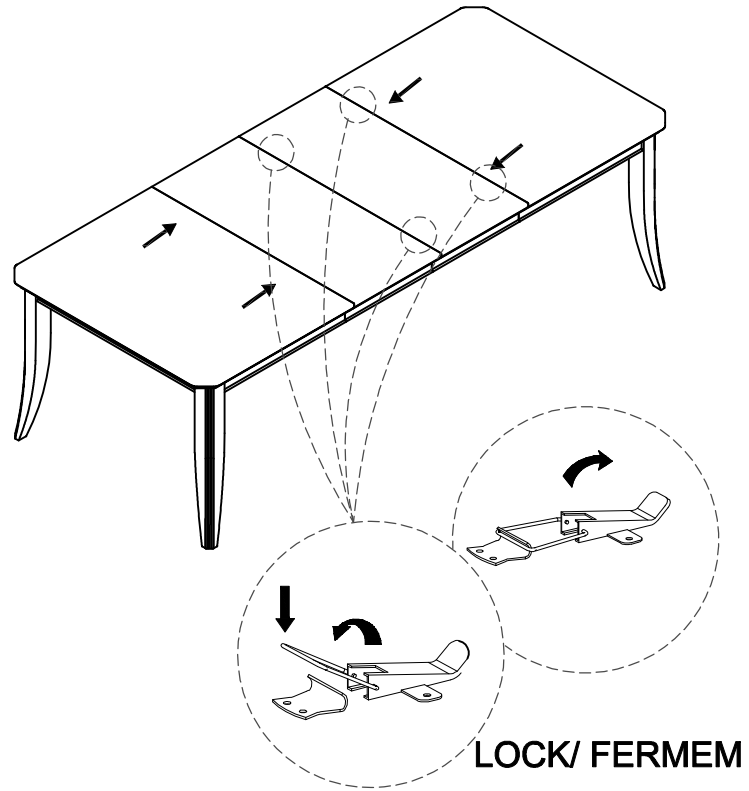

OPTION 1

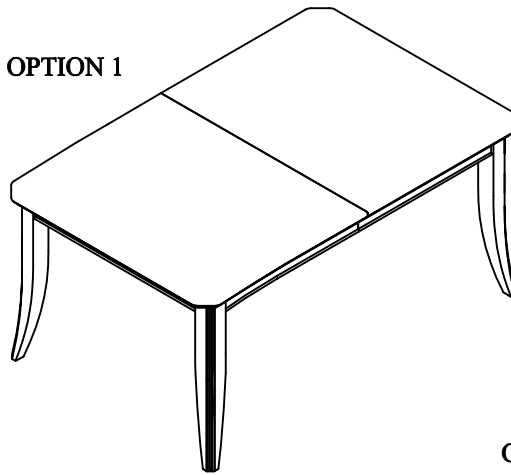

OPTION 2

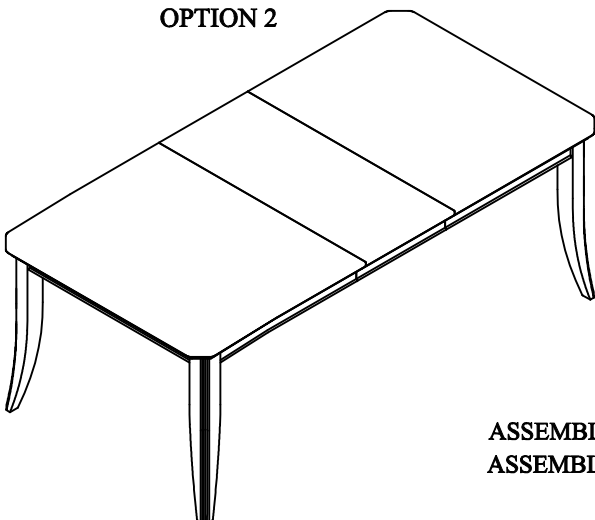

OPTION 3

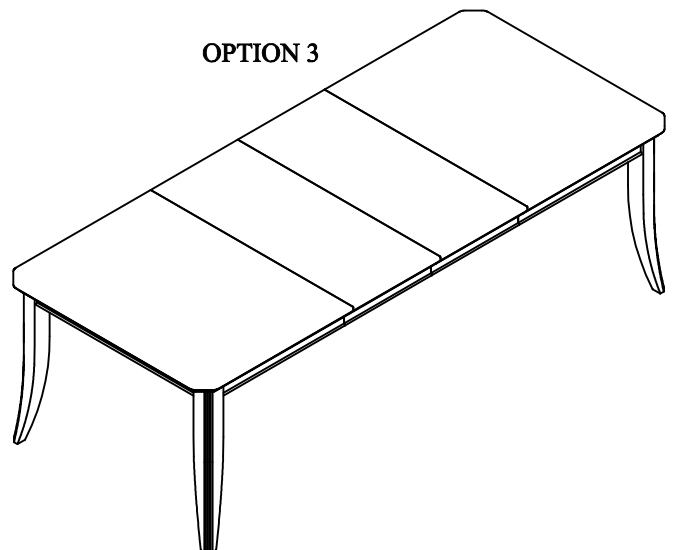

ASSEMBLY COMPLETED /  
ASSEMBLAGE COMPLETÉ