

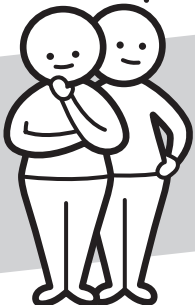

**Two People**



**Required**

**5893-1/5893-3/5893K-1/5893K-3**  
**Queen Bed/King Bed**  
**Grand lit/Tres grand lit**



Thank you for purchasing this product from Mazin Furniture. Please take the time to read and follow the instructions below. Check that you have all parts and hardware before assembly. Parts apparently missing are often found in the packing materials. If you do not have all the parts listed, have your dealer contact us and they will be sent to you immediately.

Merci d'avoir acheté ce produit de Mazin Furniture. Veuillez lire et suivre les instructions ci-dessous. Vérifiez avant le montage que vous avez toutes les pièces et fixations. Les pièces qui semblent manquer se trouvent souvent dans les matériaux d'emballage. Si vous n'avez pas toutes les pièces de la liste, demandez à votre détaillant et nous vous les enverrons immédiatement.

### Cleaning Instructions / Instructions de nettoyage

Protect from direct sunlight, direct heat and weather. All covers will fade over time. Do not remove cover for cleaning. Vacuum regularly using low suction. Professional cleaning recommended. Blot food and liquid spills immediately with a dry, white, clean cloth. Do not rub. If required for further cleaning, use a mild non-coloured, pure soap solution made from soap flakes mixed with warm water. Dry in shade away from direct heat and sunlight. Allow to dry thoroughly.

Protéger de la lumière directe du soleil, de la chaleur directe et des intempéries. Toutes les couvertures s'estomperont avec le temps. Ne retirez pas le couvercle pour le nettoyer. Passez l'aspirateur régulièrement en utilisant une faible aspiration. Nettoyage professionnel recommandé. épongez immédiatement les aliments et les liquides renversés avec un chiffon sec, blanc et propre. Ne pas frotter. Si nécessaire pour un nettoyage plus poussé, utilisez une solution savonneuse douce et non colorée à base de flocons de savon mélangés à de l'eau tiède. Sécher à l'ombre à l'abri de la chaleur directe et du soleil. Laisser sécher complètement.

# Parts list/Liste des parties

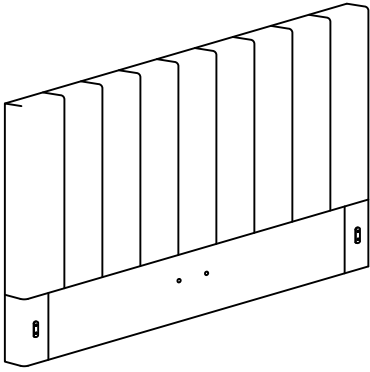

Headboard (P1)/Tête de lit (P1)

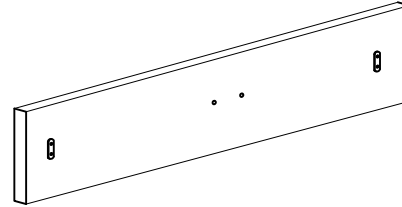

Footboard (P2)/Pied de pied (P2)

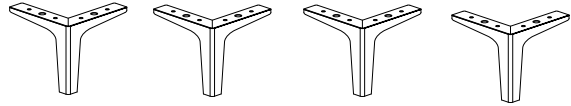

Headboard Footboard Leg (P3)/Tête de pied jambe de pied (P3)

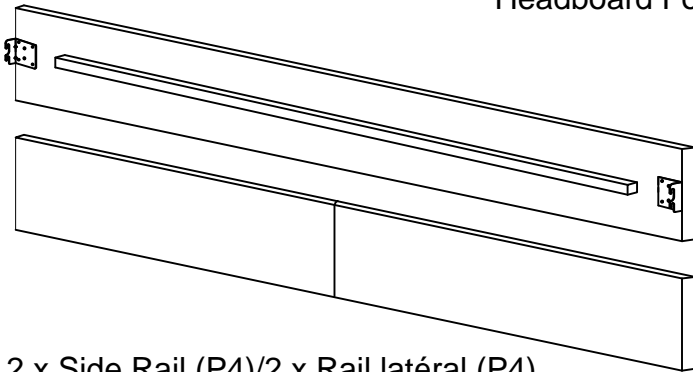

2 x Side Rail (P4)/2 x Rail latéral (P4)

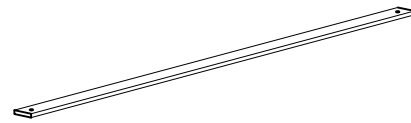

Timber Cross Rail (P11)/Bois Cross Rail (P11)

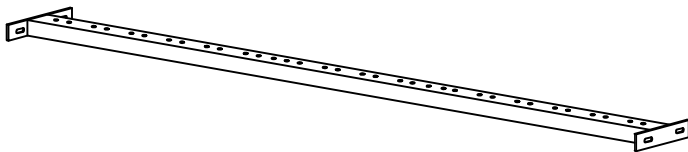

Centre Rail (P6)/Rail central (P6)

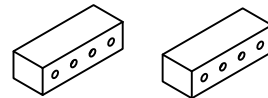

2 x Footboard Leg Support Wood (P5)  
2 x bois de Support des pieds (P5)

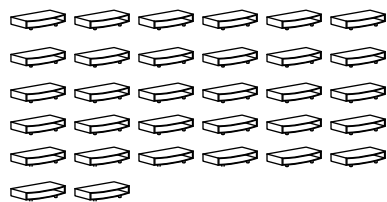

32 x End Connectors (P8)/Connecteurs d'extrémité 32 x (P8)

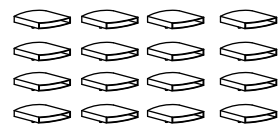

16 x Centre Connectors (P9)/Connecteurs centraux 16 x (P9)

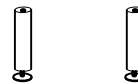

2 x Support Leg (P7)/2 x Jambe d'appui (P7)

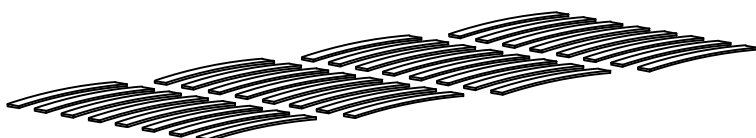

32 x Slats (P10)/32 x Slats (P10)

# Hardware pack/Liste De Quincaillerie



8 x Short Bolts  
8 boulons courts  
(H1)

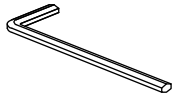

Large Allen Key  
Grande clé Allen  
(H2)



4 x Large Screws  
4 x grandes vis  
(H3)

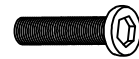

4 x Large Bolts  
4 boulons de grande taille  
(H4)



10 x Large Washers  
10 fois plus de rondelles  
(H5)



8 x Small Bolts  
8 x petits boulons  
(H6)



6 x Medium Bolts  
6 x boulons moyens  
(H7)



4 x Spring Washer  
4 x laveur à ressort  
(H8)

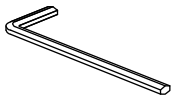

Small Allen Key  
Petite clé Allen  
(H9)



6 x Small Screws  
6 x petites vis  
(H10)

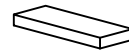





1 x Felt pad  
1 x feutre  
(H11)

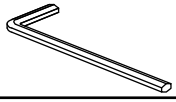

8 x Small Washers  
8 x petites rondelles  
(H12)

## Step 1/étape 1



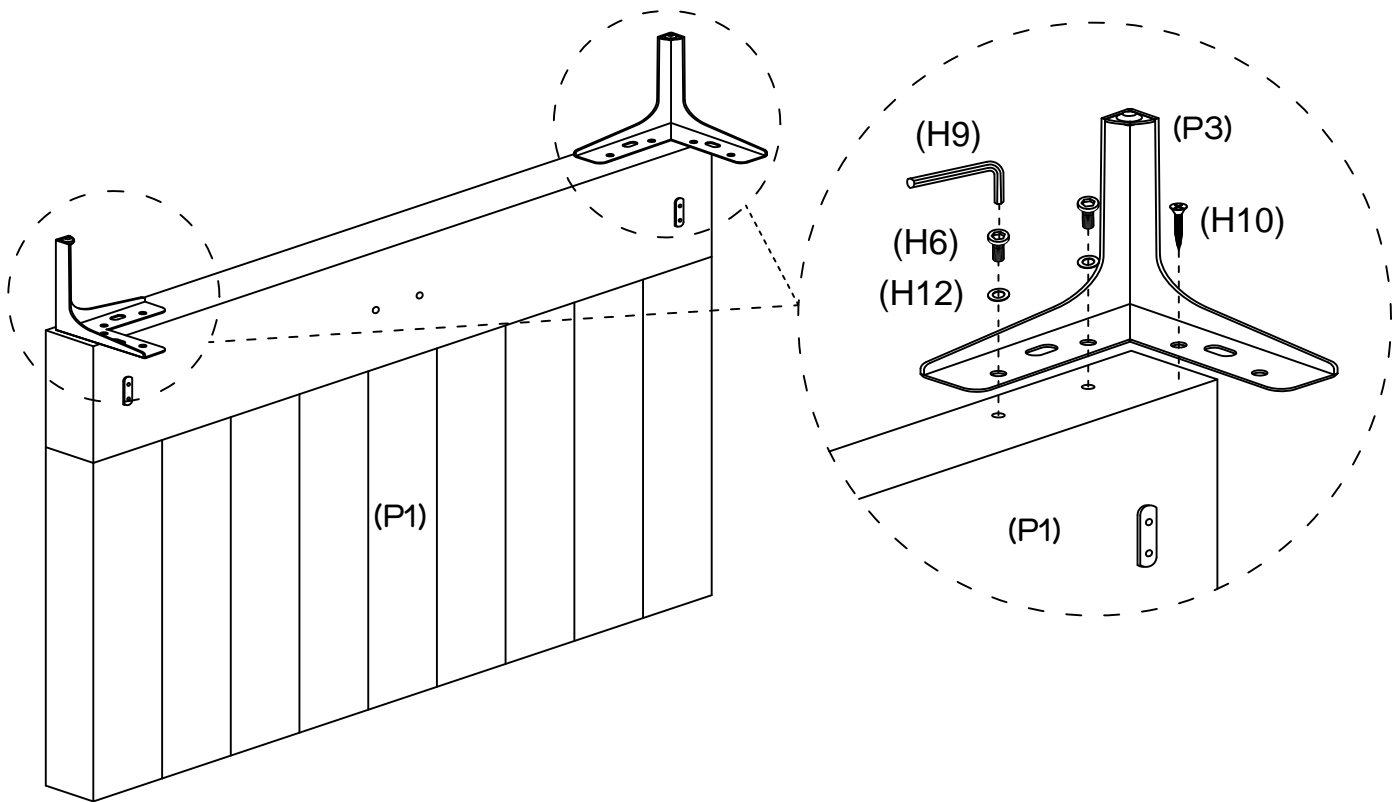



You will need / Vous aurez besoin		
		
4 x Small Bolts 4 x petits boulons (H6)	Small Allen Key Petite clé Allen (H9)	2 x Small Screws 2 x petites vis (H10)
		
4 x Small Washers 4 x petites rondelles (H12)	Phillips Head Screwdriver (not provided) directeur tournevis (non fourni)	

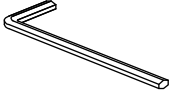

Attach 2 x headboard legs (P3) to the bottom of headboard (P1) using 4 x small washers (H12), 4 x small bolts (H6) and 2 x small screws (H10), fully tighten with small allen key (H9).

Attacher 2 x jambes avant (P3) au fond de la tête de lit (P1) en utilisant 4 x petites rondelles (H12), 4 x petites boulons (H6) et 2 x petites vis (H10). Serrez entièrement avec la petite clé d'Allen (H9).

## Step 2/étape 2



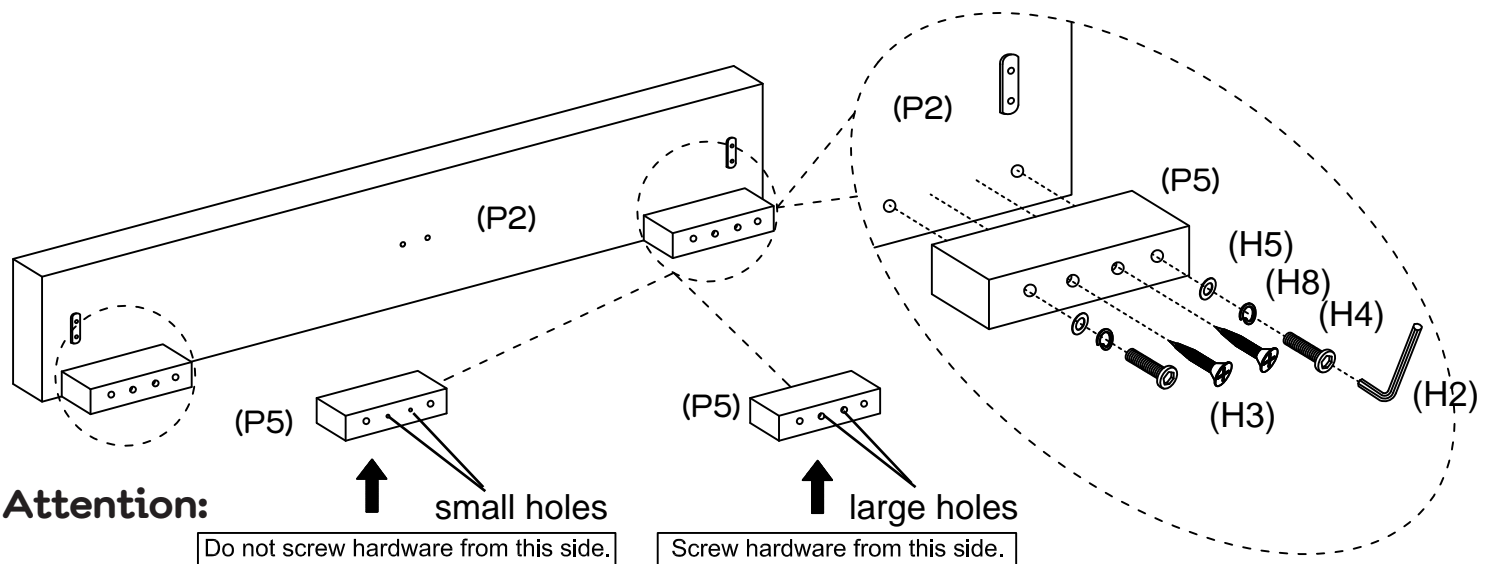

You will need / Vous aurez besoin		
		
Large Allen Key Grande clé Allen (H2)	4 x Large Screws 4 x grandes vis (H3)	4 x Large Bolts 4 boulons de grande taille (H4)
		
4 x Large Washers 4 fois plus de rondelles (H5)	4 x Spring Washer 4 x laveur à ressort (H8)	Phillips Head Screwdriver (not provided) directeur tournevis (non fourni)

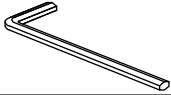

Attach 2 x footboard legs supports wood (P5) to the footboard (P2) with 4 x large washers (H5), 4 x spring washers (H8) and 4 x large bolts (H4) by using large allen key (H2). Then screw 4 x large screws (H3) by using phillips head screwdriver (not provided).

Attacher 2 x jambes de pied au pied de pied (P2) avec 4 x grands rondelles (H5), 4 x rondelles à ressort (H8) et 4 x boulons de grande taille (H4) en utilisant une grande clé d'Allen (H2). Puis visser 4 x grandes vis (H3) en utilisant un tournevis à tête de Phillips (non fourni).

## Step 3/étape 3

You will need / Vous aurez besoin		
		
4 x Small Bolts 4 x petits boulons (H6)	Small Allen Key Petite clé Allen (H9)	2 x Small Screws 2 x petites vis (H10)
		
4 x Small Washers 4 x petites rondelles (H12)	Phillips Head Screwdriver (not provided) directeur tournevis (non fourni)	

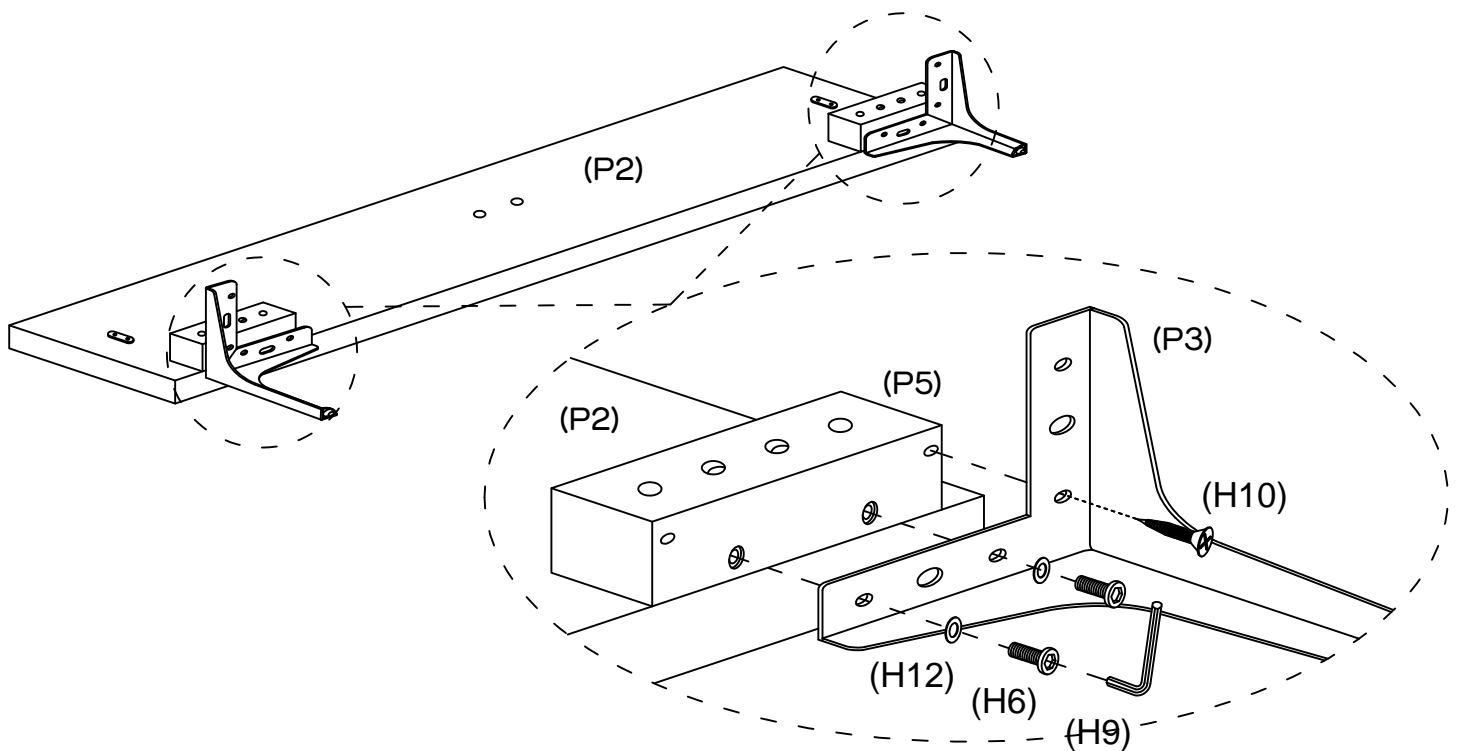

Attach 2 x footboard legs (P3) to the leg support wood support (P5) with 4 x small washers (H12), and 4 x Small bolts (H6), fully tighten with small allen key (H9).

Then screw 2 x small screws (H10) by using phillips head screwdriver (not provided).

Attacher 2 x jambes de pied (P3) au support de jambe support en bois (P5) avec 4 x petites rondelles (H12). et 4 petits boulons (H6), serrés avec une petite clé Allen (H9).

Puis visser 2 x petites vis (H10) en utilisant un tournevis à tête de Phillips (non fourni).

## Step 4/étape 4

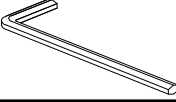
You will need / Vous aurez besoin	
	
8 x Short Bolts 8 boulons courts (H1)	Large Allen Key Grande clé Allen (H2)

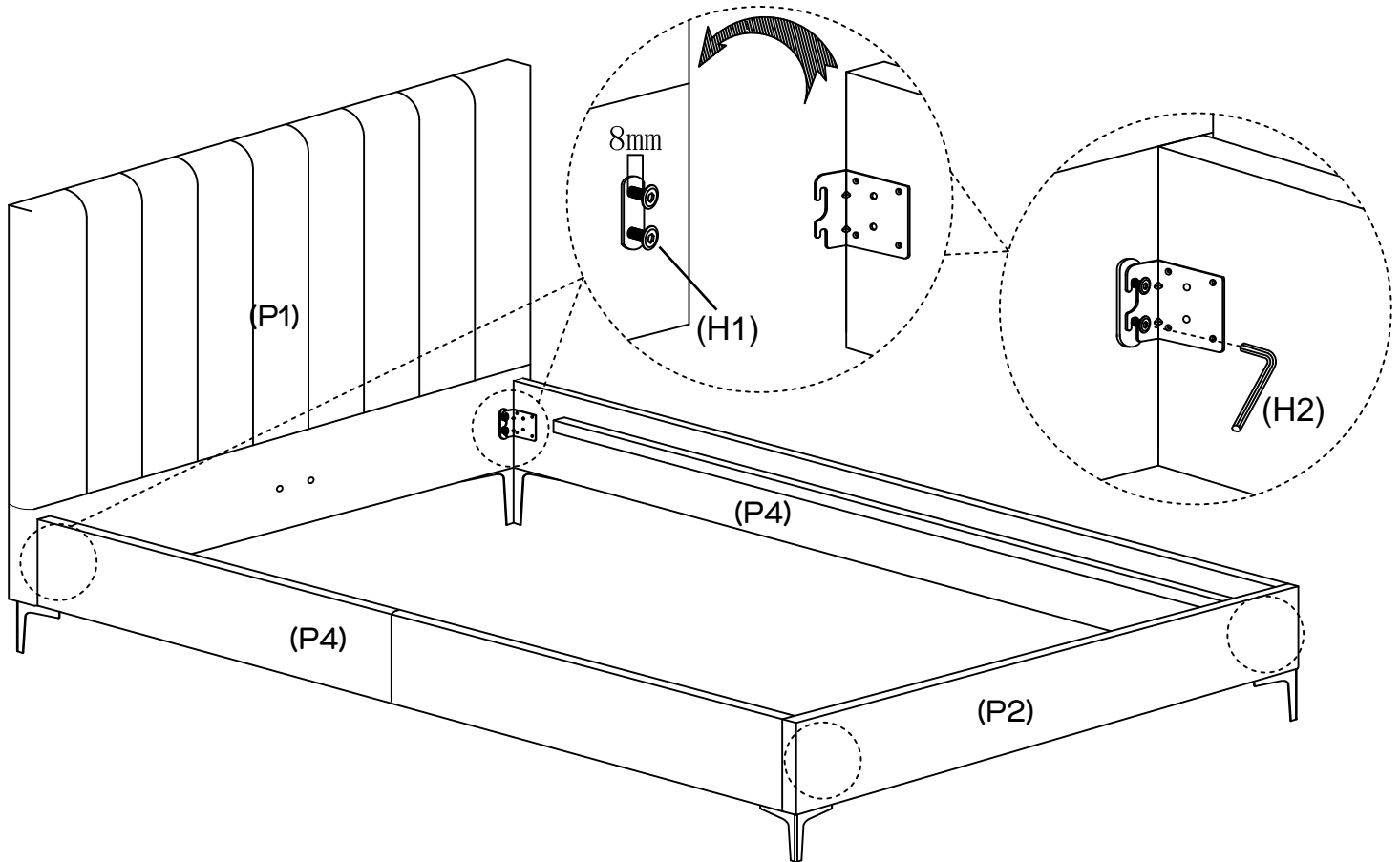



Install the 8 x short bolts (H1) to the brackets of the headboard (P1) and footboard (P2) by using the large allen key (H2) as shown, do not tighten the bolts and keep them 8mm loose. Then attach side rails (P4) to headboard (P1) and footboard (P2) by slotting the bracket on the side rails (P4) over the bolt as shown. No need to tighten bolts until step 8.

Installer les boulons courts de 8 x (H1) sur les crochets du hayon avant (P1) et du pied de taille (P2) en utilisant Comme indiqué, ne serrez pas les boulons et ne les relâchez pas de 8mm. Alors attache Rails latéraux (P4) à tête (P1) et à pied (P2) en coupant le support sur les rails latéraux (P4) Au-dessus du verrou. Pas besoin de serrer les boulons jusqu'à l'étape 8.

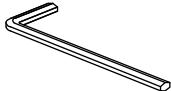

## Step 5/étape 5

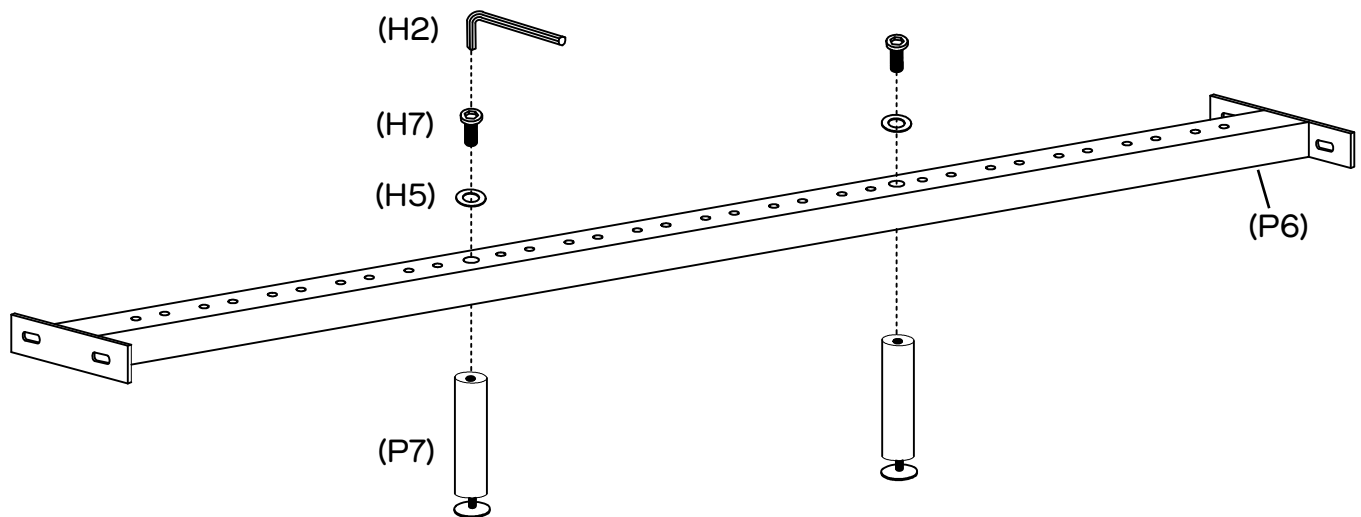

You will need / Vous aurez besoin		
		
Large Allen Key Grande clé Allen (H2)	2 x Large Washers 2 fois plus de rondelles (H5)	2 x Medium Bolts 2 x boulons moyens (H7)



Attach the support legs (P7) to the centre rail (P6) by using 2 x medium bolts (H7) and 2 x washers (H5) as shown. Tighten medium bolts (H7) by using large allen key (H2).

Fixer les montants du soutènement (P7) au rail central (P6) en utilisant 2 boulons moyens (H7) et 2 x laveurs (H5) comme indiqué. Serrer les boulons moyens (H7) avec une clé Allen (H2).

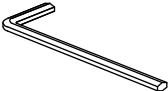
## Step 6/étape 6

You will need / Vous aurez besoin		
		
Large Allen Key Grande clé Allen (H2)	4 x Large Washers 4 fois plus de rondelles (H5)	4 x Medium Bolts 4 x boulons moyens (H7)

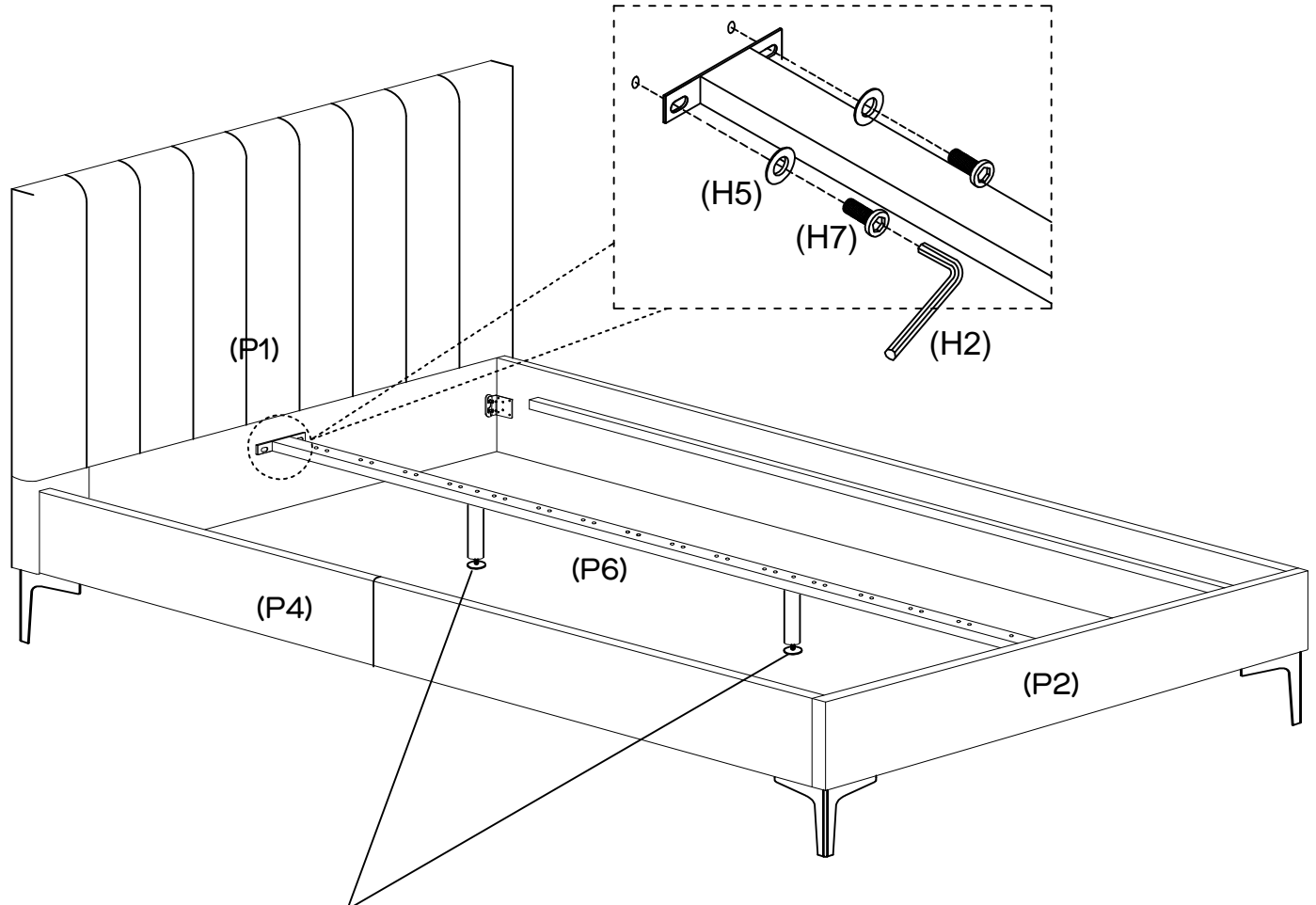



Adjust to be 10mm gap from floor to the bottom of support legs.

Réglez à 10mm d'intervalle entre le sol et le bas des jambes de soutènement.

Slot the centre rail (P6) into the headboard (P1) and footboard (P2) with 4 x medium bolts (H7) and 4 x large washers (H5) by using large allen key (H2). No need to tighten bolts until step 8.

Introduire le rail central (P6) dans le hayon avant (P1) et le marchepied (P2) avec 4 boulons moyens (H7) et 4 x de gros rondelles (H5) en utilisant une grande clé d'Allen (H2). Pas besoin de serrer les boulons jusqu'à l'étape 8.

## Step 7/étape 7

You will need / Vous aurez besoin		
		
32 x End Connectors Connecteurs d'extrémité 32 x (P8)	16 x Centre Connectors Connecteurs centraux 16 x (P9)	32 x Slats 32 x Slats (P10)

1

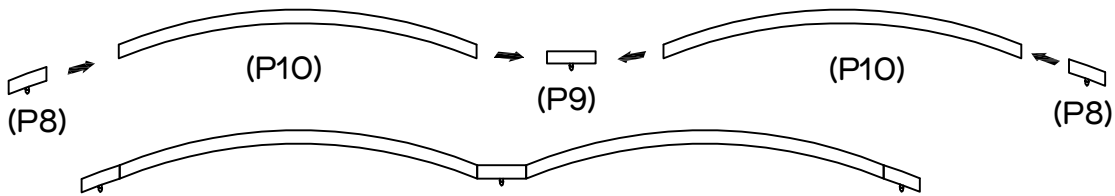

Attach 2 x end connectors (P8), 1 x centre connector (P9) and 2 x slats together as shown, repeat this for the remaining slats.

2 connecteurs d'extrémité (P8), 1 connecteur central (P9)

Et 2 lattes x ensemble comme indiqué, répétez cela pour les lattes restantes.

2

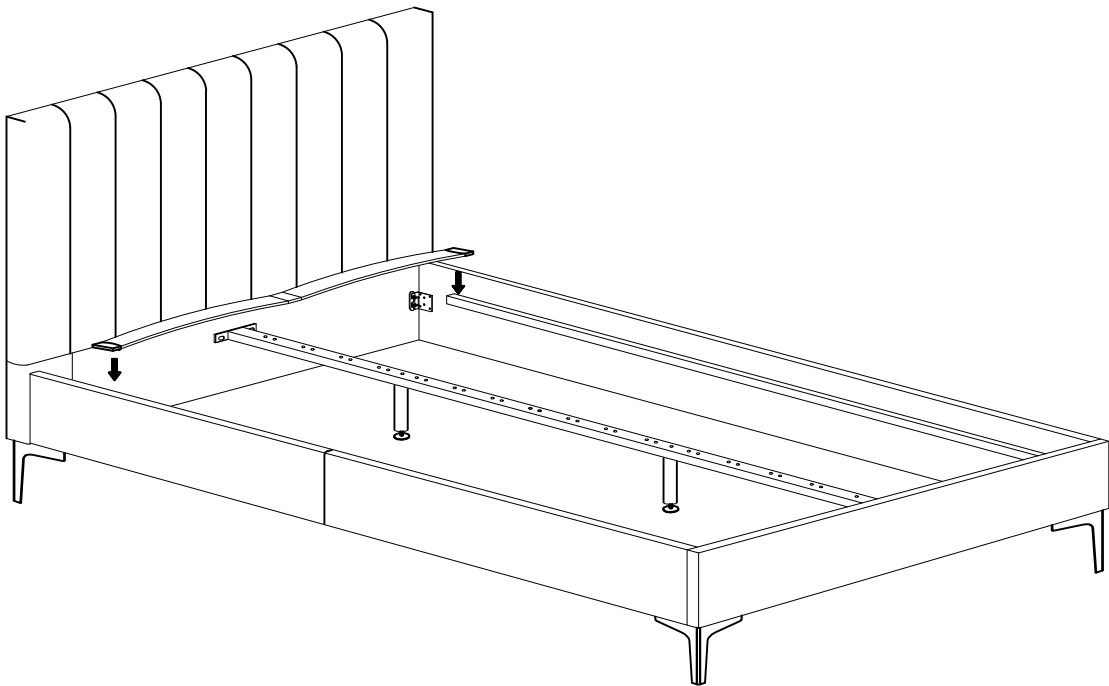

Lower the completed slat (P8),(P10) and (P9) into side rails (P4), Ensure the connectors are in place over the side rail holes and centre rail holes, then apply downward pressure on the slat (P10) with the end connectors (P8) and the centre connectors (P9) until the connectors are fully inserted into the rail.

Abaisser les raccords terminés (P8),(P10) et (P9) dans les rails latéraux (P4), s'assurer que les connecteurs sont en place Placer les voies latérales et les voies centrales, puis exercer une pression vers le bas sur les voies Slat (P10) avec les connecteurs d'extrémité (P8) et les connecteurs centraux (P9) jusqu'au connecteurs Sont complètement insérées dans le rail.

3

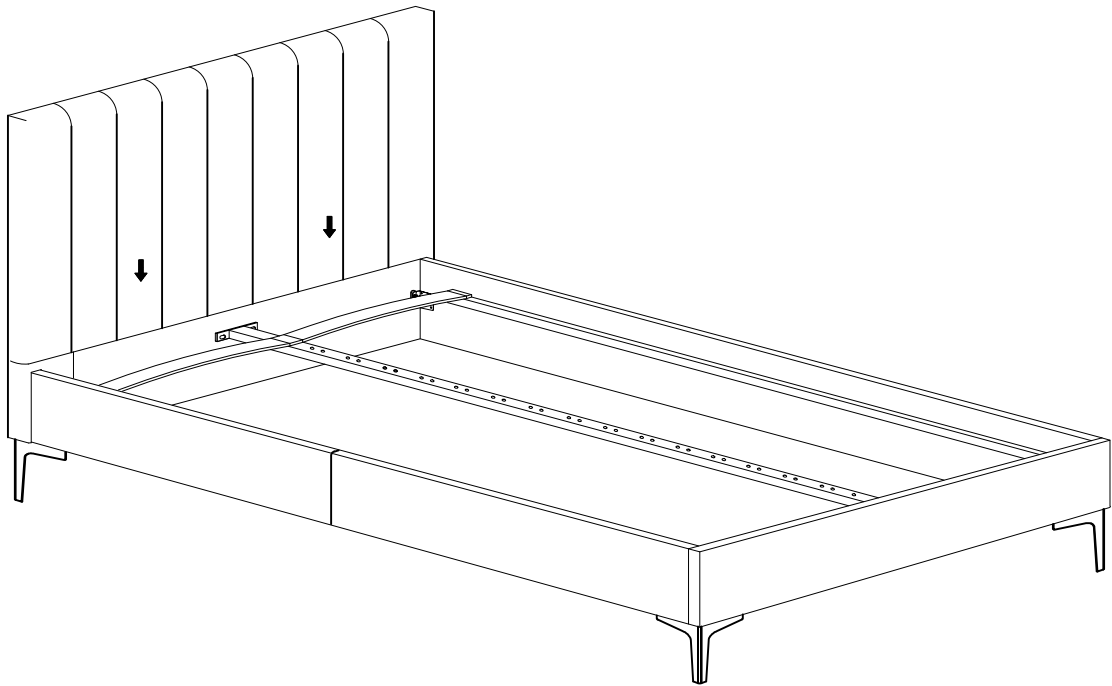

Sometimes it makes it easier to line up the hole if you press down in the middle of the slat to flatten it out.

Parfois, il est plus facile d'aligner le trou si vous appuyez au milieu du bec pour l'aplatir.

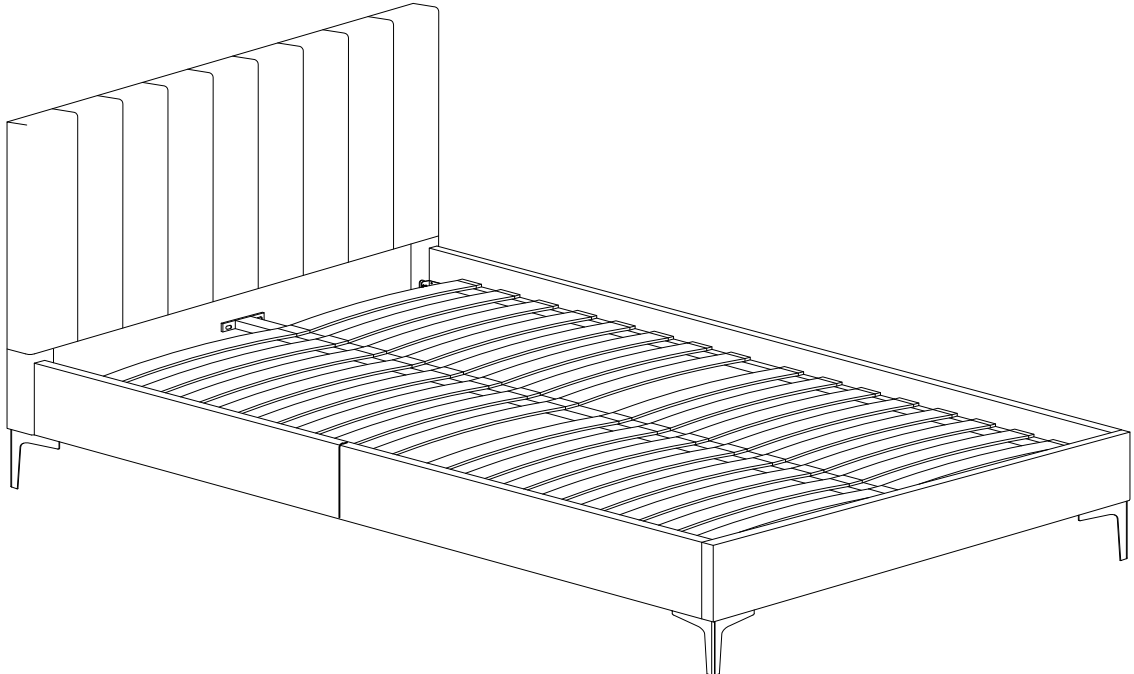

4



Repeat for every bed slat until finished.

Répétez pour chaque lit jusqu'à la fin.

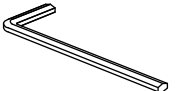
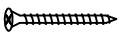
## Step 8/étape 8

You will need / Vous aurez besoin			
			
Large Allen Key Grande clé Allen (H2)	2 x Small Screws 2 x petites vis (H10)	1 x Felt pad 1 x feutre (H11)	Phillips Head Screwdriver (not provided) directeur tournevis (non fourni)

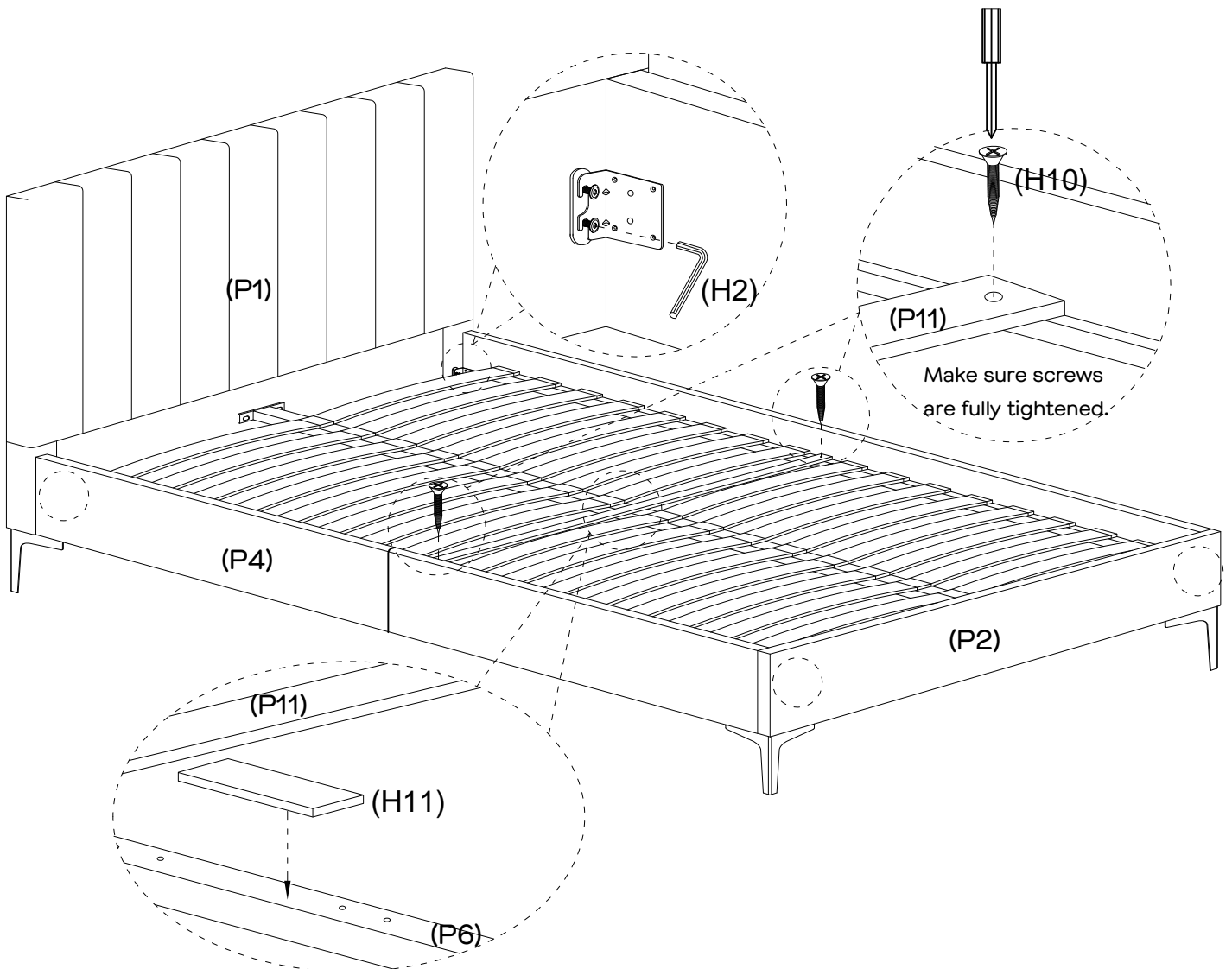

Make sure that the bed is square

Attach the timber cross rail (P11) to the centre of side rails (P4) by using 2 x small screws (H10). Then attach the felt pad (H11) to the centre of centre rail (P6) under the cross rail. Now tighten all the bolts on the centre rail (P6), headboard (P1) and footboard (P2).

Assurez-vous que le lit soit carré

Attachez le rail transversal en bois (P11) au centre des rails latéraux (P4) en utilisant 2 x petites vis (H10). Attachez ensuite le tampon de feutre (H11) au centre du rail central (P6) sous le rail transversal. Maintenant serrez tous les boulons sur le rail central (P6), le headboard (P1) et le footboard (P2).

## Step 9/étape 9

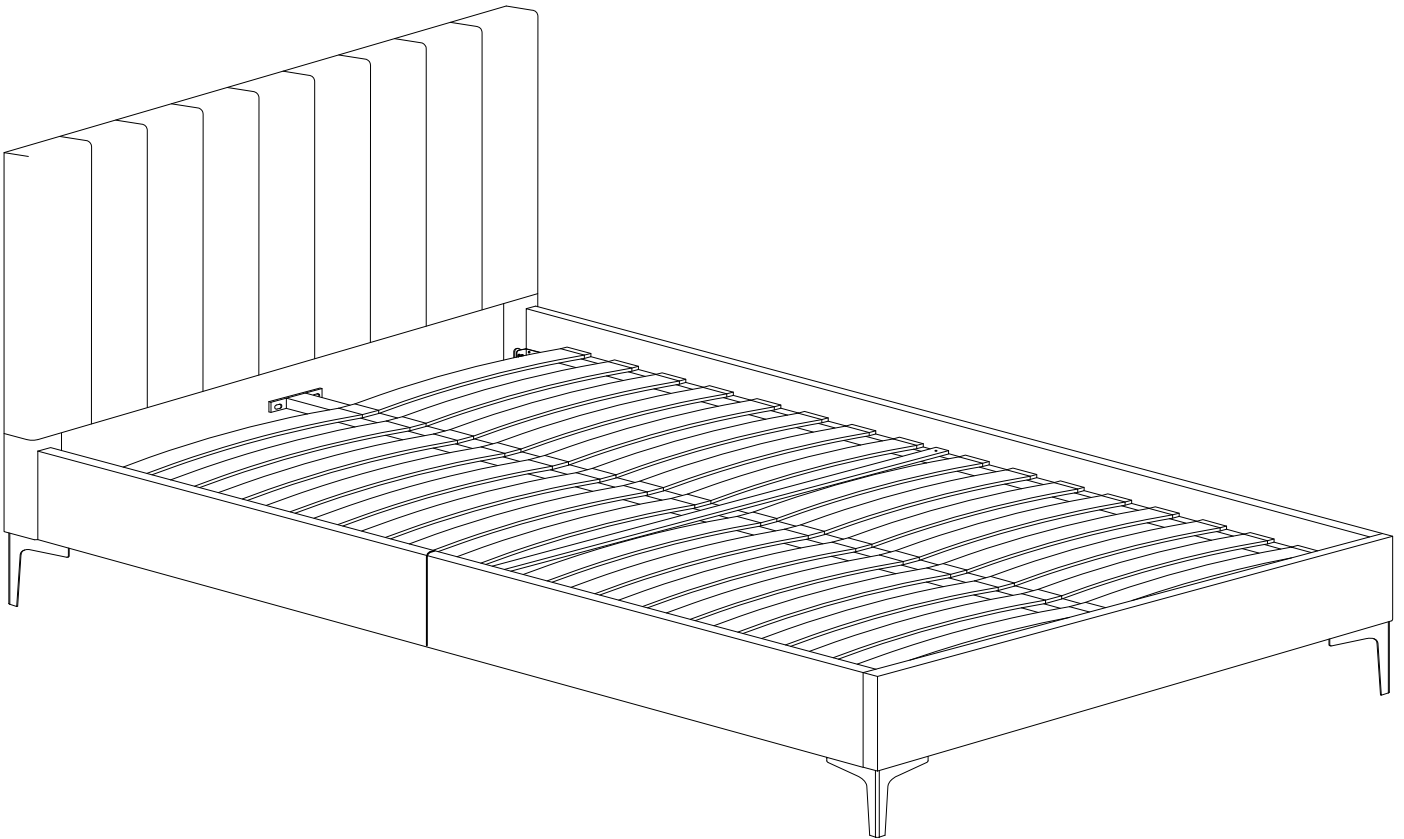

## Job complete!/Travail terminé!

In the interest of our environment please dispose  
of all packaging thoughtfully.

Dans l'intérêt de notre environnement, veuillez disposer  
De tous les emballages soigneusement.