







ASSEMBLY INSTRUCTIONS







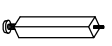

GROUP NO.: 5874 CK BED

ITEM NO.: 5874KNV-1 / 5874KTE-1 / 5874KGY-1 EK / CK HEADBOARD
5874KNV-3CK / 5874KTE-3CK / 5874KGY-3CK CK FOOTBOARD & SIDE RAILS, SLATS

Thank you for purchasing this product. Please take time to read and follow the instructions below. Check that you have all parts and hardware before assembly. Parts apparently missing are often found in the packing materials. If you do not have all the parts listed, have your dealer contact us and they be sent to you immediately.

! It is recommended to install protective pads under all legs and supports to avoid damage or scratches when placing furniture on a wood floor or other hard surface, and to limit indentation and prevent discoloration if placing on carpet.

| PARTS LIST | | | |
|------------|--------------------|---|-------|
| NO. | DESCRIPTION | SKETCH | QTY |
| A | Headboard |  | 1 PC |
| B | Footboard |  | 1 PC |
| C | Side rail |  | 2 PCS |
| D | Bed Slat |  | 4 PCS |
| E | Slats support legs |  | 8 PCS |
| F | Bun Foot - L |  | 1 PC |
| G | Bun Foot - R |  | 1 PC |

| HARDWARE LIST | | | | |
|---------------|---------------|---|-------------|--------|
| NO. | DESCRIPTION | SKETCH | SIZE | QTY |
| 1 | Flat Washer |  | Ø5/16**19m | 2 PCS |
| 2 | Spring Washer |  | Ø5/16" | 2 PCS |
| 3 | Bolt |  | Ø5/16**75mm | 2 PCS |
| 4 | Allen Key |  | 4mm*100mm | 1 PC |
| 5 | Thread Bold |  | Ø5/16**80mm | 8 PCS |
| 6 | Curve Washer |  | | 8 PCS |
| 7 | Hexagonal Nut |  | | 8 PCS |
| 8 | Wrench |  | | 1 PC |
| 9 | Screw |  | M4 x 30mm | 16 PCS |

* ABOVE HARDWARE ARE PACKED IN BOX-3CK FOR ASSEMBLY

STEP 1: Attach Bun foot L/R (F),(G) to Footboard (B) using Allen bolts (3), Spring washer (2), Flat washer (1), by Allen Key (4).

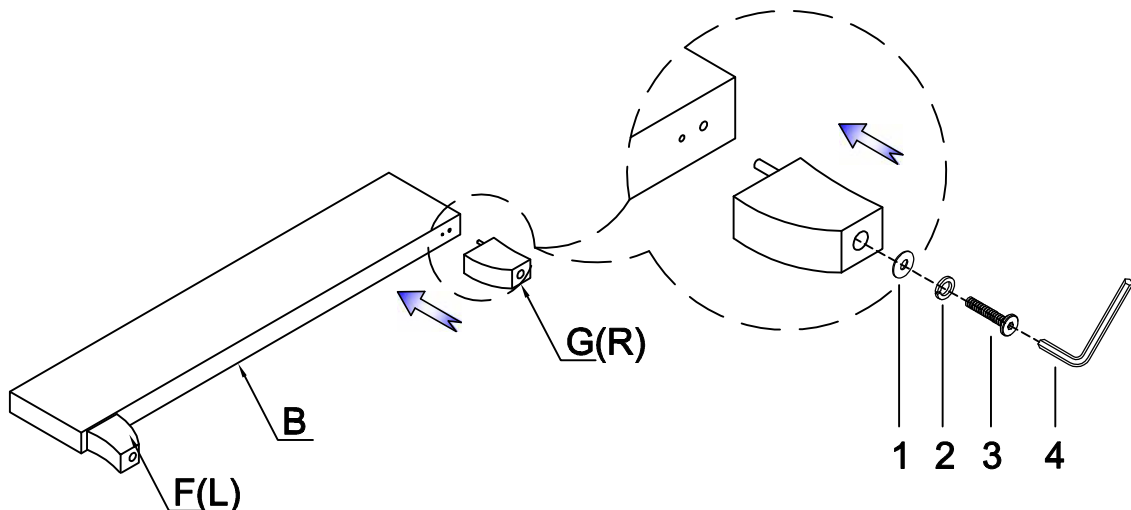



ASSEMBLY INSTRUCTIONS

HOME ELEGANCE

GROUP NO.: 5874 CK BED

ITEM NO.: 5874KNV-1 / 5874KTE-1 / 5874KGY-1 EK / CK HEADBOARD

5874KNV-3CK / 5874KTE-3CK / 5874KGY-3CK CK FOOTBOARD & SIDE RAILS, SLATS

STEP 2: Attach Side rail (C) to Headboard (A) & Footboard (B) using Thread bolts (5), Curve washer (6), Hexagonal nut(7) by Wrench (8).

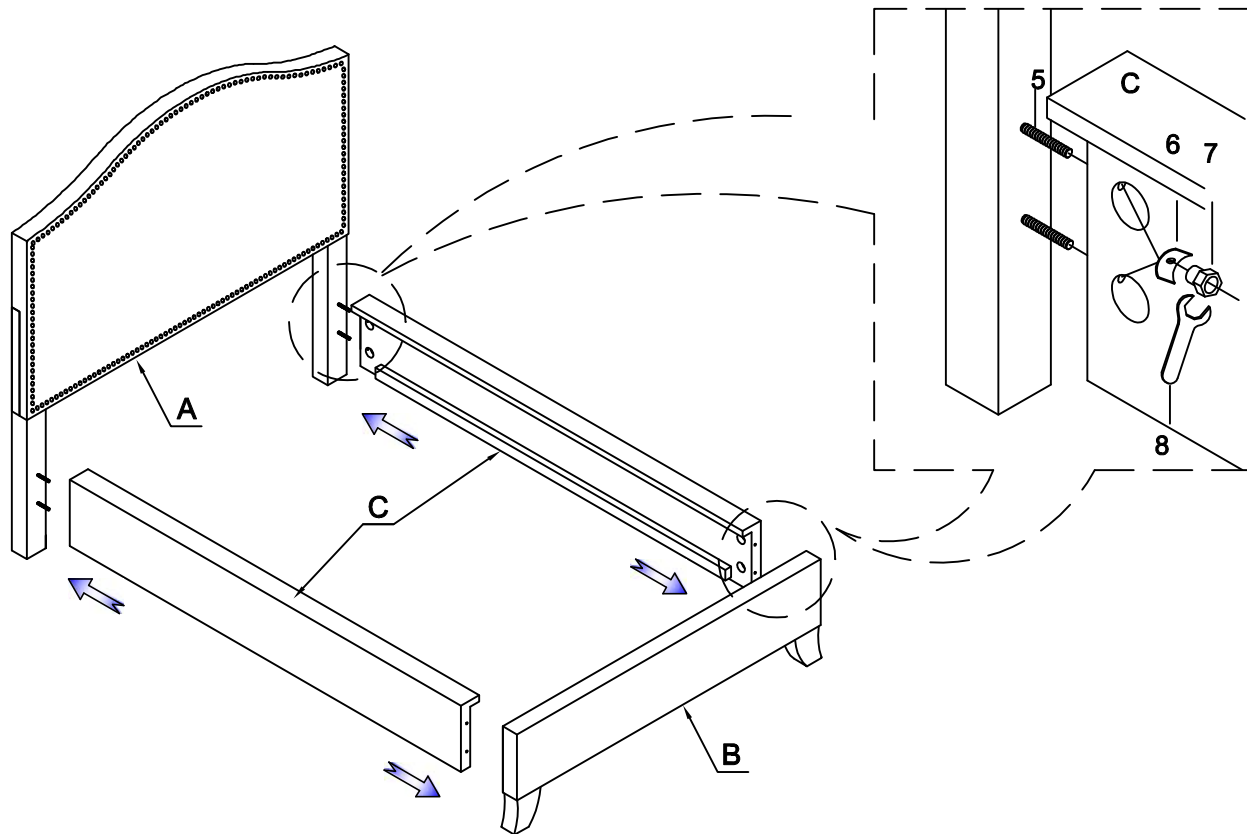

STEP 3: Attach Slat support legs (E) to Slat (D).

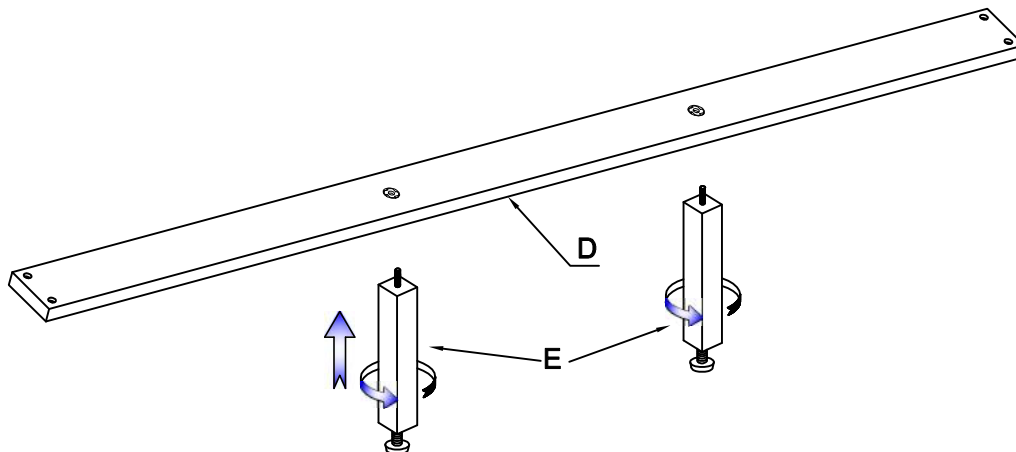



ASSEMBLY INSTRUCTIONS

GROUP NO.: 5874 CK BED

HOME ELEGANCE

ITEM NO.: 5874KNV-1 / 5874KTE-1 / 5874KGY-1 EK / CK HEADBOARD

5874KNV-3CK / 5874KTE-3CK / 5874KGY-3CK CK FOOTBOARD & SIDE RAILS, SLATS

STEP 4: Attached slat (D) to bed side rail (C) by using screw (9).

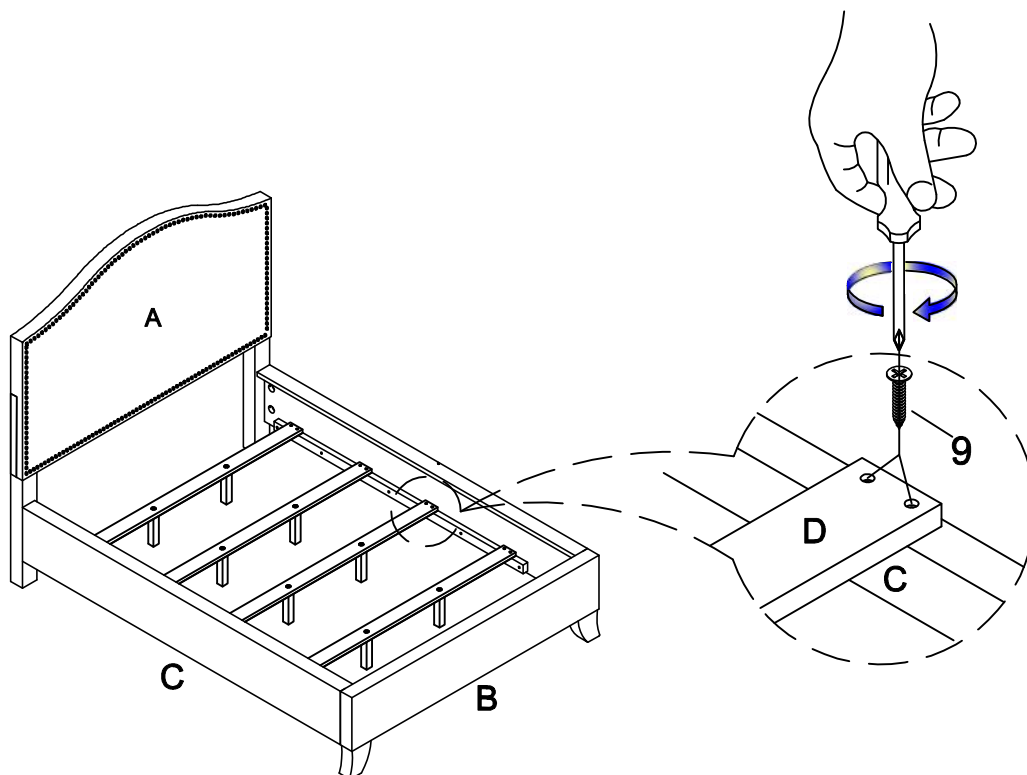

COMPLETED

