



ASSEMBLY INSTRUCTION

HOME ELEGANCE

2052TW-1

TWIN BED, WHITE

PART LIST:

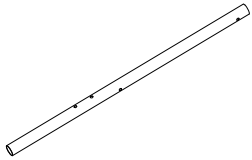

A: LSF Headboard post
x 1pc

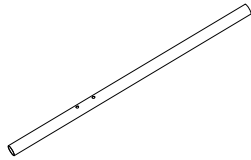

B: RSF Headboard post
x 1pc

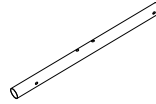

C: LSF Footboard post
x 1pc

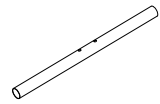

D: RSF Footboard post
x 1pc

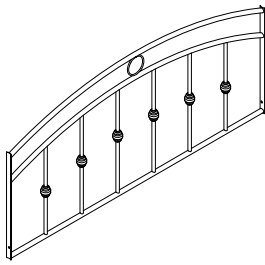

E: Headboard & Footboard Frame
x 2pcs

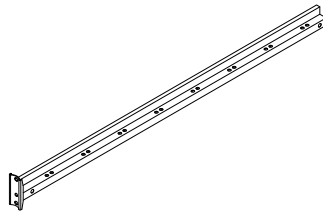

F: Rail section (1)
x 2pcs

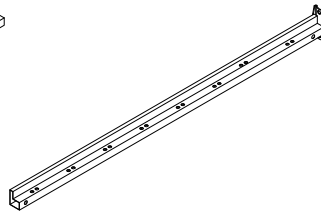

G: Rail section (2)
x 2pcs

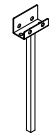

H: Rail Support Legs
x 2pcs

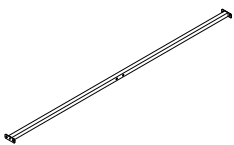

J: Center support Bar
x 1pc

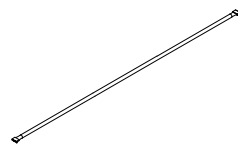

N: Slat with Connectors
x 16pcs



O: Finial
x 4pcs

HARDWARE LIST:



1: Bolt 1/4*46mm
x 4pcs



2: Bolt 1/4*16mm
x 20pcs



3: Nut
x 4pcs



4: Allen Key
x 1pc

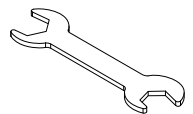

5: Wrench
x 1pc

Note: Please do not tighten all bolts until the bed is assembled completely.

STEP 1

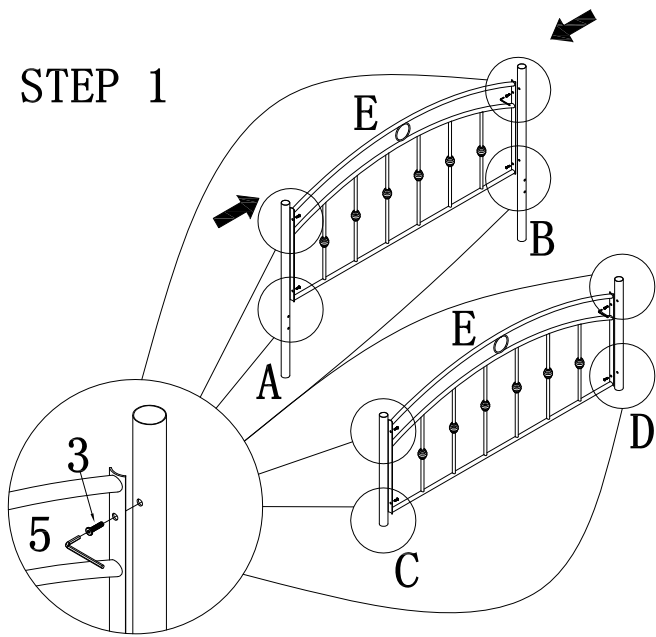

STEP 2

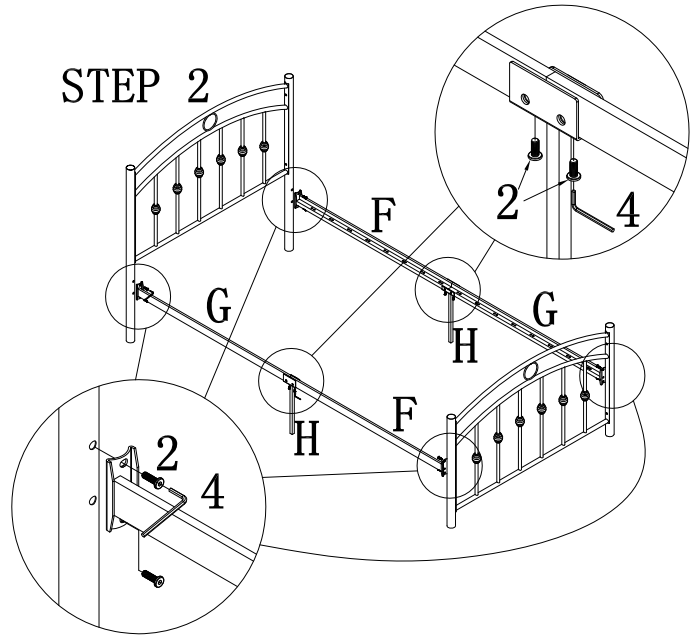

STEP 3

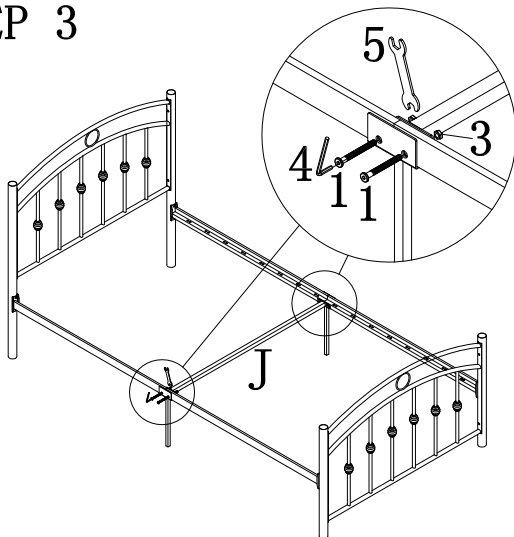

STEP 4

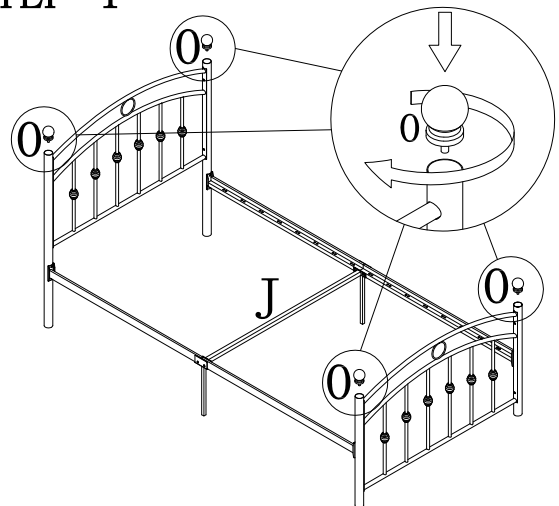

STEP 5

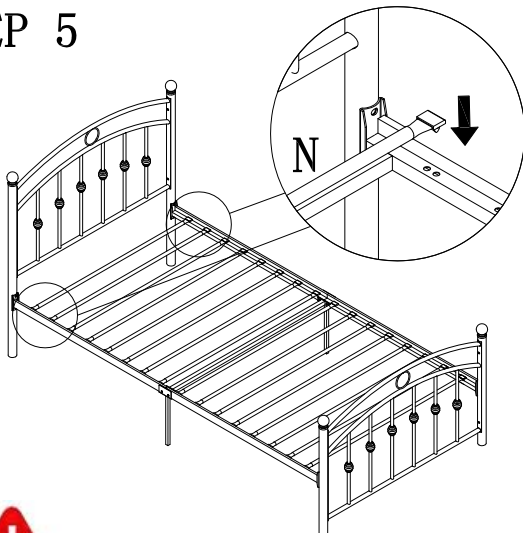

COMPLETED

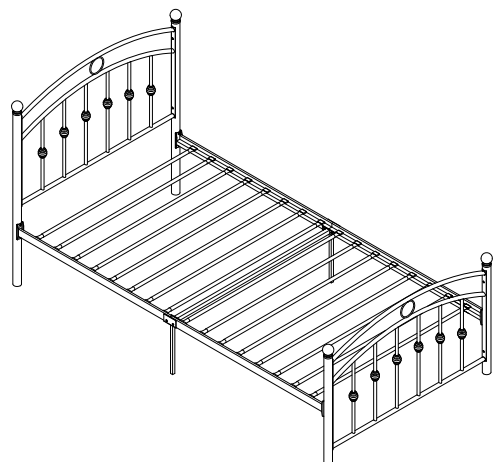

For items use on wooden floor, hard surfaces or carpets, it is recommended to install protective pads under all legs and supports to avoid/prevent from damages/scratches and discoloration.