







# ASSEMBLY INSTRUCTION INSTRUCTION D'ASSEMBLAGE





2046T-1 Twin Headboard / Tête de Lit- Lit Jumeau  
 2046F-1 Full Headboard / Tête de Lit- Lit Double  
 2046-1 Queen Headboard / Tête de Lit -Grand Lit  
 2046K-1 King Headboard / Tête de Lit -Tres Grand Lit

Thank you for purchasing this product. Please take time to read and follow the instructions below. Check that you have all parts and hardware before assembly. Parts apparently missing are often found in the packing materials. If you do not have all the parts listed, have your dealer contact us and they will be sent to you immediately.

Merci d'avoir acheté ce produit. Veuillez lire et suivre les instructions ci-dessous. Vérifiez avant le montage que vous avez toutes les pièces et fixations. Les pièces qui semblent manquer se trouvent souvent dans les matériaux d'emballage. Si vous n'avez pas toutes les pièces de la liste, appelez-nous et nous vous les enverrons immédiatement.

-  It is recommended to install protective pads under all legs and supports to avoid damage or scratches when placing furniture on a wood floor or other hard surface, and to limit indentation and prevent discoloration if placing on carpet.
-  Il est recommandé de placer des coussins protecteurs sous tous les pieds et toutes les bases des meubles pour éviter d'endommager ou d'égratigner les planchers en bois ou autres surfaces dures, et pour limiter l'empreinte et empêcher la décoloration quand les meubles reposent sur la moquette.
-  Hardware may loosen over time. Periodically check to make sure all connections are tight. Re-tighten if necessary.
-  Le matériel peut se desserrer au fil du temps. Vérifiez périodiquement que toutes les connexions sont serrées. Serrer à nouveau si nécessaire.

PARTS LIST / LISTE DE PIÈCES		
No	DESCRIPTION	Q'TY
P1	 HEADBOARD / TÊTE DE LIT	1 pc
P2	 HEADBOARD LEG(LSF) / PIED L	1 pc
P3	 HEADBOARD LEG(RSF) / PIED R	1 pc

HARDWARE LIST / LISTE DE QUINCAILLERIE		
No	DESCRIPTION	Q'TY
H1	 Bolt / Boulon 1/4"-18 x1 3/5"	6pcs
H2	 Spring Washer / Rondelle D' Arrêt 1/4" x 11/32" x 15/32" x 1/21"	6pcs
H3	 Flat Washer / Rondelle Plate 1/4" x 11/32" x 3/4" x 1/21"	6pcs
H4	 Allen Key / Clé Allen 5/32" x 2 1/4"	1pc

Hardware set are packed in 2046T/F/K-1 For Assembly.

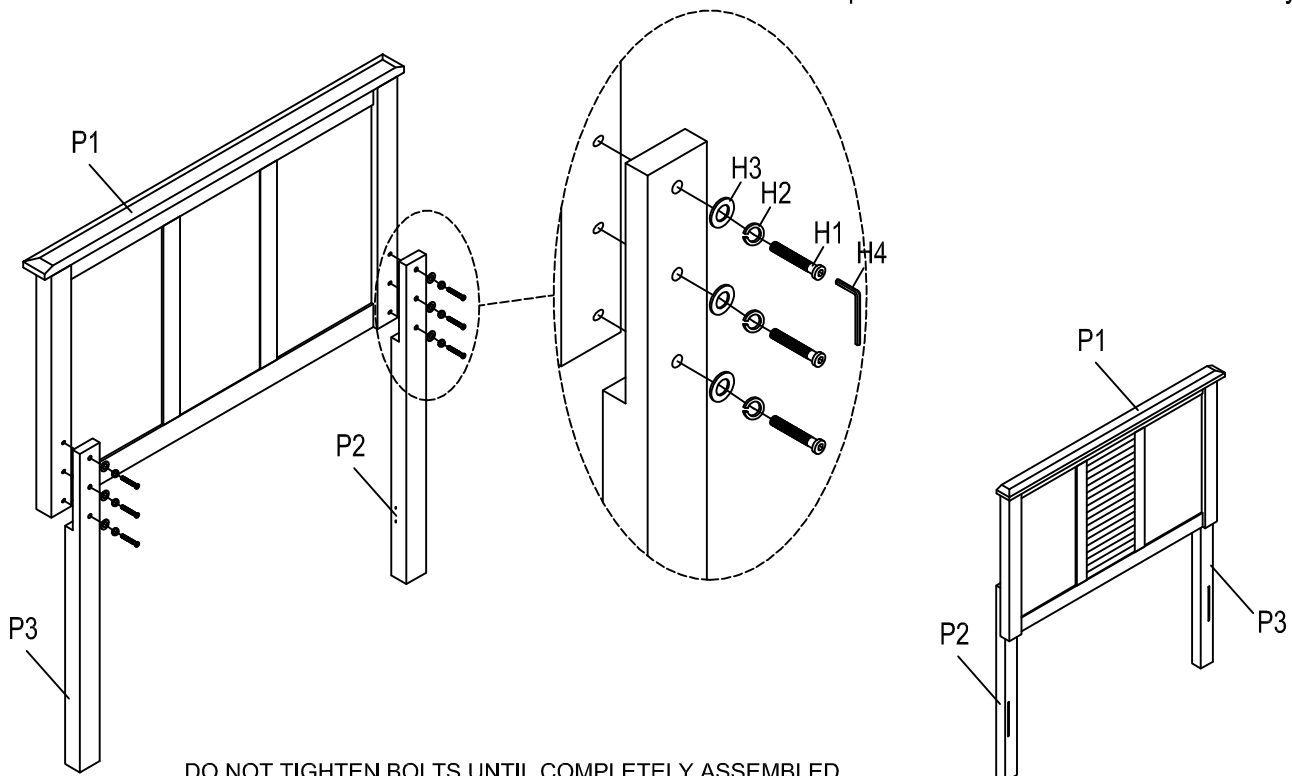

DO NOT TIGHTEN BOLTS UNTIL COMPLETELY ASSEMBLED  
 / NE PAS SERRER LES BOULONS JUSQU'À CE QUE LE  
 MONTAGE SOIT COMPLETMENT TERMINE