













ASSEMBLY INSTRUCTIONS / INSTRUCTION D'ASSEMBLAGE

1962-9
589-9

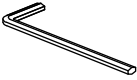

Chest / Commode

Thank you for purchasing this product from Mazin Furniture. Please take the time to read and follow the instructions below. Check that you have all parts and hardware before assembly. Parts apparently missing are often found in the packing materials. If you do not have all the parts listed, have your dealer contact us and they will be sent to you immediately.

Merci d'avoir acheté ce produit de Mazin Furniture. Veuillez lire et suivre les instructions ci-dessous. Vérifiez avant le montage que vous avez toutes les pièces et fixations. Les pièces qui semblent manquer se trouvent souvent dans les matériaux d'emballage. Si vous n'avez pas toutes les pièces de la liste, demandez à votre détaillant et nous vous les enverrons immédiatement.

HARDWARE LIST		LISTE DE QUINCAILLERIE		PARTS LIST I LISTE DE PIÈCES	
A		8 x Short Bolts 8 x Boulons courts		1	 Bedside(P1) Côté lit(P1) 1 PC
B		8 x Washers 8 x rondelles		2	 Legs(P2) Les jambes(P2) 4PCS
C		1 x Allen Key 1 x Clé allen			
P ANTI-TIPPING HARDWARE PACK			PACKMATÉRIEL ANTI-BASCULEMENT		
D		Brackets équerre 2PCS		G	 Nylon Strap Bracelet en nylon 1PC
E		Short Screws Vis courtes 2PCS		H	 Plastic Screw anchor Ancrage à vis en plastique 1PC
F		Large Screws Grandes vis 2PCS			

STEP 1/ETAPE 1

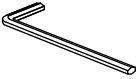

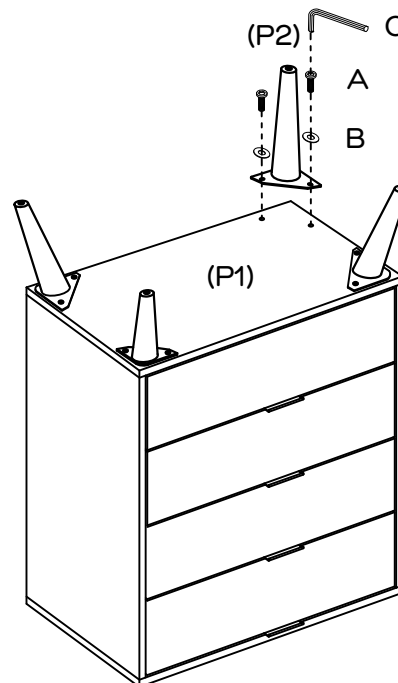

You will need / Vous aurez besoin		
		
8 x Short Bolts 8 x Boulons courts A	8 x Washers 8 x rondelles B	Allen Key Clé allen C



Attach legs (P2) to the bottom of Bedside (P1) with 8 x short bolts(A) and 8 x washers (B) by using allen key (C).

Attcher les pieds (P2) au bas du chevet (P1) avec 8 boulons courts (A) et 8 x rondelles (B) en utilisant la clé allen (C).

STEP 2/ETAPE 2

You will need / Vous aurez besoin				
				
D x 2PCS	E x 2PCS	F x 2PCS	G x 1PC	H x 1PC

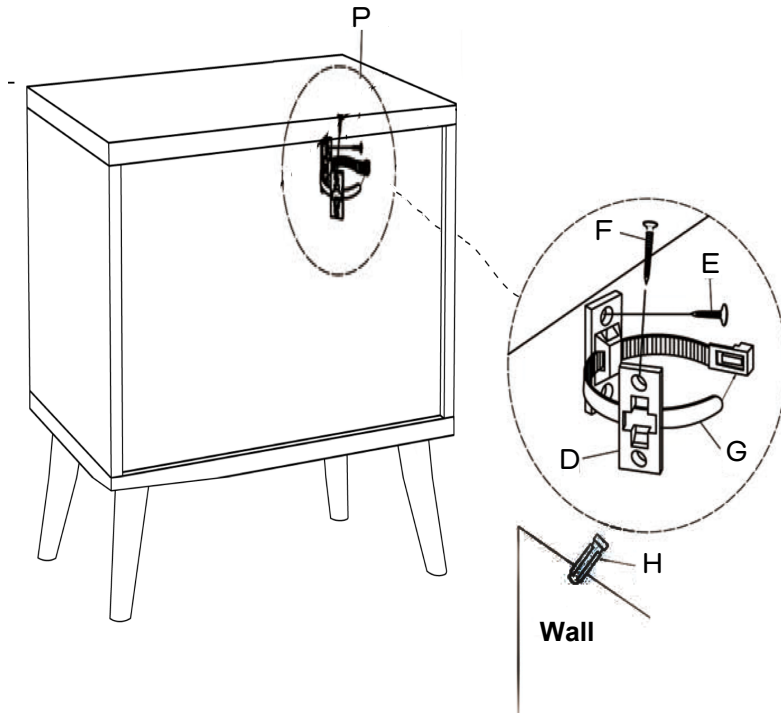

Remove the Anti-Tipping Hardware Pack (P) from fitting box, assemble in to avoid tipping.

1. Attach one of the wall brackets (D) and secure to the back top the back edge of the Bedside using the short screw (E).
2. Mark the location on the wall for mounting the second wall bracket (D). Create appropriate sized hole in the wall and insert the plastic screw anchor (H). Secure the bracket to the wall using the Large screw (F).
3. Place the furniture to the bracket on the back edge of unit is line with the bracket on the wall.
4. Lace an end of the nylon strap (G) down through each bracket, check to make sure the strap is securely laced and laced to the brackets

Retirez le pack matériel anti-basculement (P) de la boîte de montage, assemblez-le dans le basculement avio.

1. Attachez l'un des supports muraux (D) et fixez à l'arrière le bord arrière du chevet à l'aide de la vis courte (E).
2. Marquez l'emplacement sur le mur pour le montage du deuxième support mural (D). Créez un trou de taille appropriée dans le mur et insérez l'ancrage à vis en plastique (H). Fixez le support au mur à l'aide de la grande vis (F).
3. Placez le meuble sur le support sur le bord arrière de l'unité est aligné avec le support sur le mur.
4. Attachez une extrémité de la sangle nylon (G) vers le bas à travers le support chaque, vérifiez que la sangle est solidement lacée et lacée aux brackets

DO NOT TIGHTEN BOLTS UNTIL COMPLETELY ASSEMBLED.

NE PAS SERRER LES BOULONS JUSQU'À CE QUE LE MONTAGE SOIT COMPLÈTMENT TERMINÉ

⚠ It is recommended to install protective pads under all legs and supports to avoid damage or scratches when placing furniture on a wood floor or other hard surface, and to limit indentation and prevent discoloration if placing on carpet.

⚠ Il est recommandé de placer des coussins protecteurs sous tous les pieds et toutes les bases des meubles pour éviter d'endommager ou d'égratigner les planchers en bois ou autres surfaces dures, et pour limiter l'empreinte et empêcher la décoloration quand les meubles reposent sur la moquette.