

# ASSEMBLY INSTRUCTIONS / INSTRUCTIONS D'ASSEMBLAGE







## GROUP NO.: 1642 FULL / QUEEN / KING BED

ITEM NO.: 1642F-1 Full Uph Headboard / Tête de Lit rembourré - Lit Double  
 1642F-2 Full Uph Footboard, Slats & Support Legs / Pied de lit rembourré/  
 Lattes et Support de Lattes - Lit Double  
 1642F-3 Full Uph Side Rails / Longérons de côtés - Lit Double  
 1642-1 Queen Uph Headboard / Tête de Lit rembourré - Grand Lit  
 1642-2 Queen Uph Footboard, Slats & Support Legs / Pied de lit rembourré/  
 Lattes et Support de Lattes - Grand Lit  
 1642-3 Queen/EK Uph Side Rails / Longérons de côtés - Grand Lit  
 1642K-1 EK/CK Uph Headboard / Tête de Lit rembourré - Tres Grand Lit  
 1642K-2 EK/CK Uph Footboard, Slats & Support Legs / Pied de lit rembourré/  
 Lattes et Support de Lattes - Tres Grand Lit





Thank you for purchasing this product. Please take time to read and follow the instructions below. Check that you have all parts and hardware before assembly. Parts apparently missing are often found in the packing materials. If you do not have all the parts listed, have your dealer contact us and they be sent to you immediately.









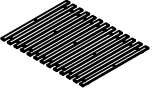
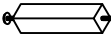

Merci d'avoir acheté ce produit. Veuillez lire et suivre les instructions ci-dessous. Vérifiez avant le montage que vous avez toutes les pièces et fixations. Les pièces qui semblent manquer se trouvent souvent dans les matériaux d'emballage. Si vous n'avez pas toutes les pièces de la liste, demandez à votre détaillant et nous vous les enverrons immédiatement.

-  It is recommended to install protective pads under all legs and support to avoid damage or scratches when placing furniture on a wood floor or other hard surface, and to limit indentation and prevent discoloration if placing on carpet.
-  Il est recommandé de placer des coussins protecteurs sous tous les pieds et toutes les bases des meubles pour éviter d'endommager ou d'égratigner les planchers en bois ou autres surfaces dures, et pour limiter l'empreinte et empêcher la décoloration quand les meubles reposent sur la moquette.
-  Hardware may loosen over time. Periodically check to make sure all connections are tight. Re-tighten if necessary.
-  Le matériel peut se desserrer au fil du temps. Vérifiez périodiquement que toutes les connexions sont serrées. Serrer à nouveau si nécessaire.

### PARTS LIST / LISTE DE PIÈCES

\* BELOW HARDWARE ARE PACKED IN 1642F-2 / 1642-2 / 1642K-2 / FOR ASSEMBLY /  
 Quincaillerie au dessus est dans boîte # 1642F-2 / 1642-2 / 1642K-2

NO.	SKETCH	DESCRIPTION	QTY
A		Headboard / Tête De Lit	1 PC
B		Footboard / Pied De Lit	1 PC
C		Side Rail - L & R / Longérons - Gauche & Droite	2 PCS
D		Bun Foot / Pied	2 PCS
E		Center Slat Support / Support de latte centrale	1 PC
F		Slat (13pcs) / Latte (13)	1 SET
G		Slat Support Leg / Pied Support Pour Lattes	5 PCS

NO.	SKETCH	DESCRIPTION	SIZE	QTY
1		Thread Bolt / Boulon De Filetage	Ø5/16"*80mm	8 PCS
2		Curve Washer / Rondelle incurvée	Ø5/16"	8 PCS
3		Hex Nut / Écrou hexagonale	Ø5/16"	8 PCS
4		Wood dowel / Goujon de bois	Ø10*40mm	2 PCS
5		Bolt / Boulon	Ø1/4"*55mm	2 PCS
6		Bolt / Boulon	Ø1/4"*32mm	5 PCS
7		Spring washer / Rondelle D'arrêt	Ø1/4"	7 PCS
8		Flat washer / Rondelle Plate	Ø1/4"*19mm	7 PCS
9		Screw / Vis	#4 x 30mm	26 PCS
10		Open Wrench / Clé		1 PC
11		Allen Key / Clé Allen	4mm * 60mm	1 PC

\* DO NOT TIGHTEN BOLTS UNTIL COMPLETELY ASSEMBLED

NE PAS SERRER LES BOULONS JUSQU'À CE QUE LE MONTAGE SOIT COMPLETMENT TERMINE

# ASSEMBLY INSTRUCTIONS / INSTRUCTIONS D'ASSEMBLAGE



## GROUP NO.: 1642 FULL / QUEEN / KING BED

- ITEM NO.: 1642F-1 Full Uph Headboard / Tête de Lit rembourré - Lit Double  
1642F-2 Full Uph Footboard, Slats & Support Legs / Pied de lit rembourré/  
Lattes et Support de Lattes - Lit Double  
1642F-3 Full Uph Side Rails / Longérons de côtés - Lit Double  
1642-1 Queen Uph Headboard / Tête de Lit rembourré - Grand Lit  
1642-2 Queen Uph Footboard, Slats & Support Legs / Pied de lit rembourré/  
Lattes et Support de Lattes - Grand Lit  
1642-3 Queen/EK Uph Side Rails / Longérons de côtés - Grand Lit  
1642K-1 EK/CK Uph Headboard / Tête de Lit rembourré - Tres Grand Lit  
1642K-2 EK/CK Uph Footboard, Slats & Support Legs / Pied de lit rembourré/  
Lattes et Support de Lattes - Tres Grand Lit

### STEP 1: ÉTAPE 1

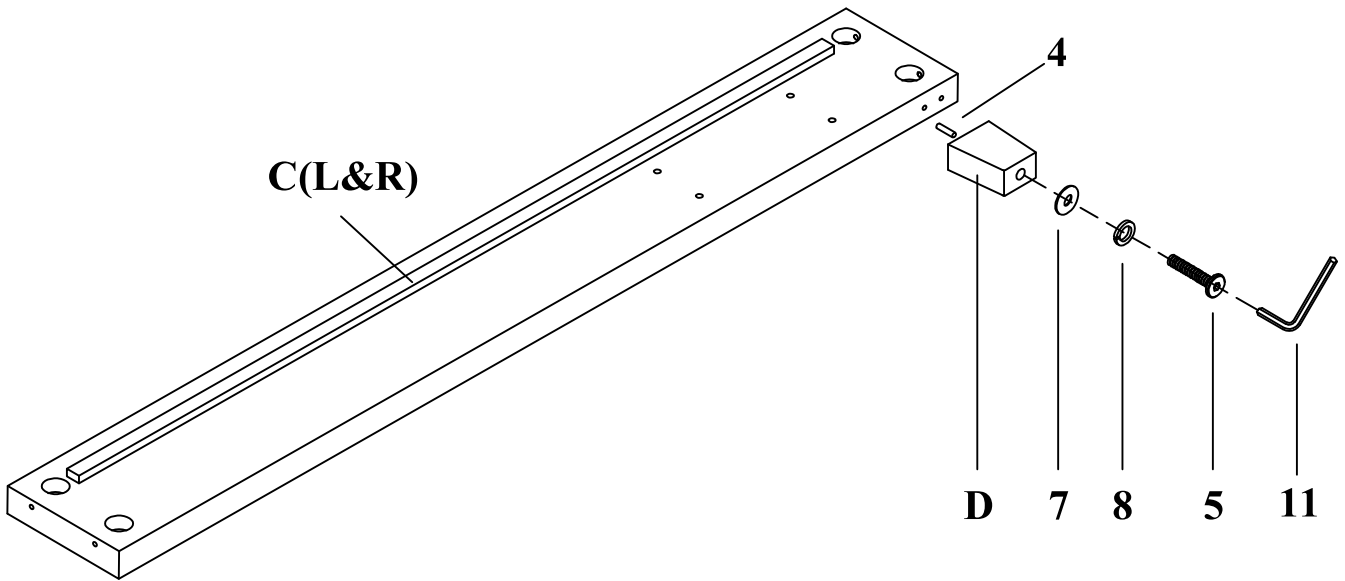

### STEP 2: ÉTAPE 2

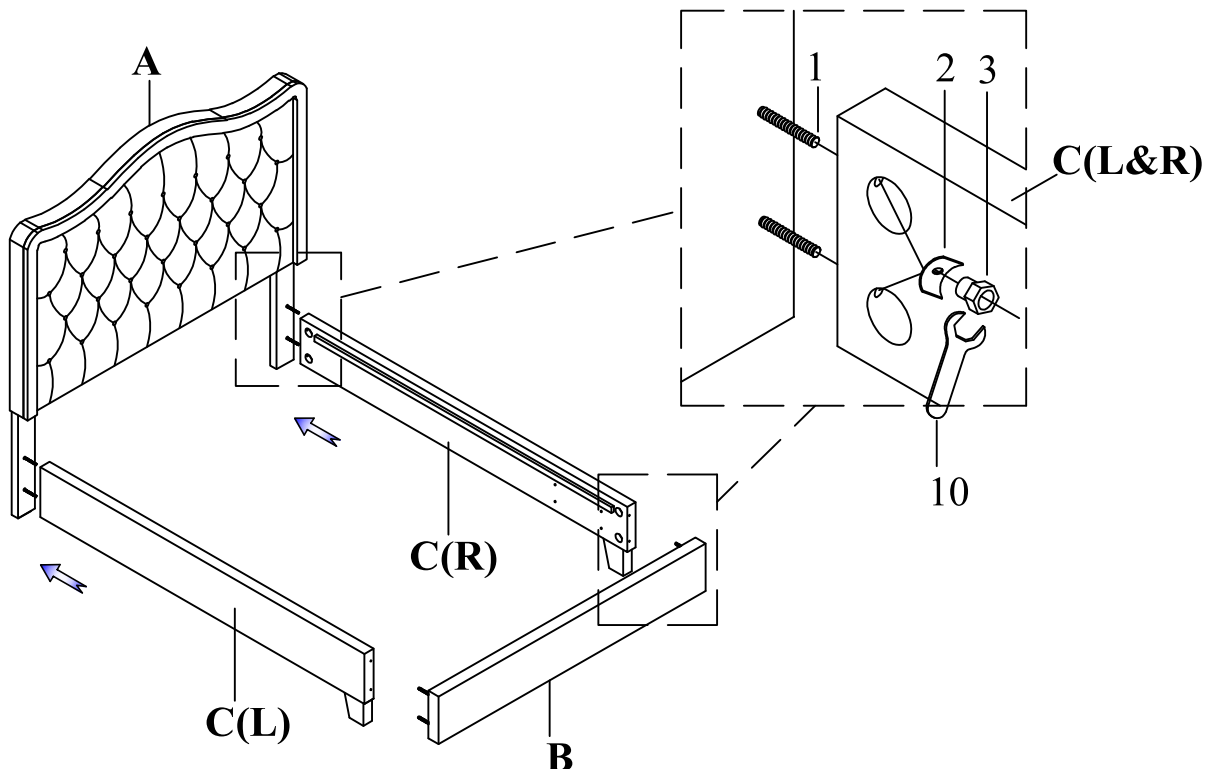

# ASSEMBLY INSTRUCTIONS / INSTRUCTIONS D'ASSEMBLAGE



## GROUP NO.: 1642 FULL / QUEEN / KING BED

ITEM NO.: 1642F-1 Full Uph Headboard / Tête de Lit rembourré - Lit Double  
1642F-2 Full Uph Footboard, Slats & Support Legs / Pied de lit rembourré/  
Lattes et Support de Lattes - Lit Double  
1642F-3 Full Uph Side Rails / Longérons de côtés - Lit Double  
1642-1 Queen Uph Headboard / Tête de Lit rembourré - Grand Lit  
1642-2 Queen Uph Footboard, Slats & Support Legs / Pied de lit rembourré/  
Lattes et Support de Lattes - Grand Lit  
1642-3 Queen/EK Uph Side Rails / Longérons de côtés - Grand Lit  
1642K-1 EK/CK Uph Headboard / Tête de Lit rembourré - Tres Grand Lit  
1642K-2 EK/CK Uph Footboard, Slats & Support Legs / Pied de lit rembourré/  
Lattes et Support de Lattes - Tres Grand Lit

### STEP 5: ÉTAPE 5

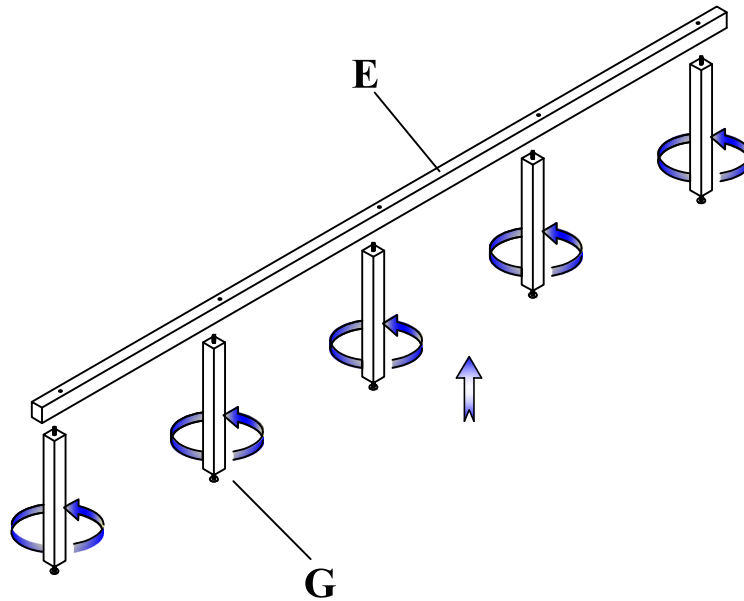

### STEP 6: ÉTAPE 6

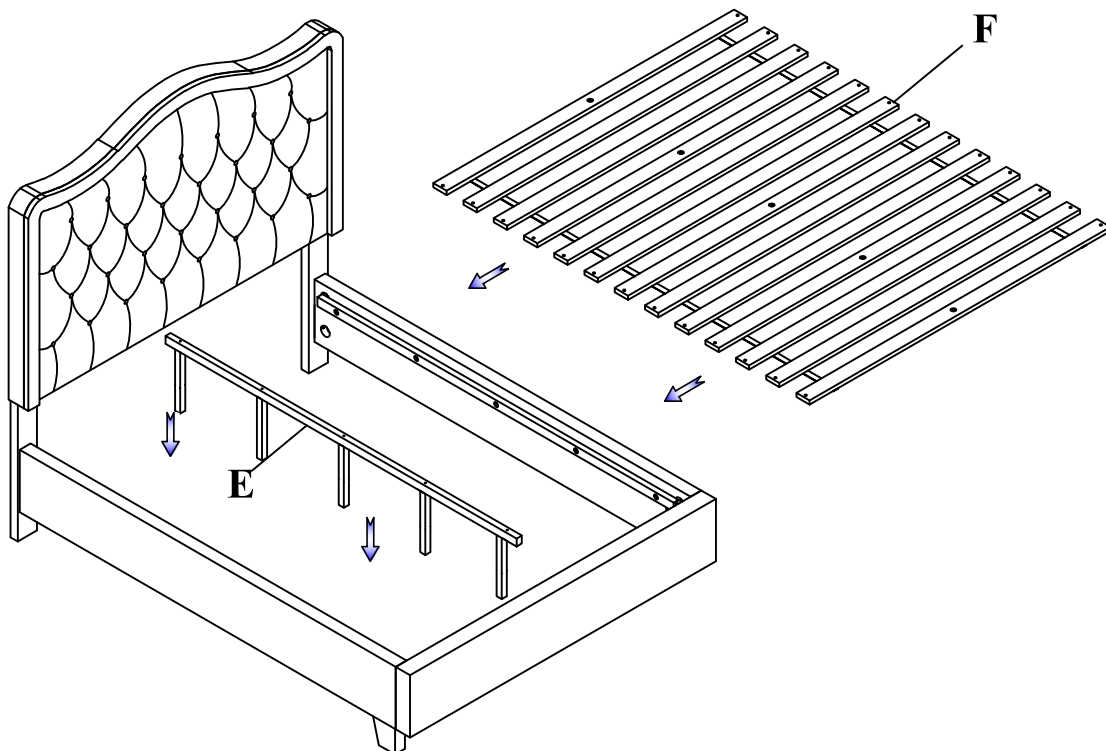

# ASSEMBLY INSTRUCTIONS / INSTRUCTIONS D'ASSEMBLAGE



## GROUP NO.: 1642 FULL / QUEEN / KING BED

ITEM NO.: 1642F-1 Full Uph Headboard / Tête de Lit rembourré - Lit Double  
1642F-2 Full Uph Footboard, Slats & Support Legs / Pied de lit rembourré/  
Lattes et Support de Lattes - Lit Double  
1642F-3 Full Uph Side Rails / Longérons de côtés - Lit Double  
1642-1 Queen Uph Headboard / Tête de Lit rembourré - Grand Lit  
1642-2 Queen Uph Footboard, Slats & Support Legs / Pied de lit rembourré/  
Lattes et Support de Lattes - Grand Lit  
1642-3 Queen/EK Uph Side Rails / Longérons de côtés - Grand Lit  
1642K-1 EK/CK Uph Headboard / Tête de Lit rembourré - Tres Grand Lit  
1642K-2 EK/CK Uph Footboard, Slats & Support Legs / Pied de lit rembourré/  
Lattes et Support de Lattes - Tres Grand Lit

### STEP 7: ÉTAPE 7

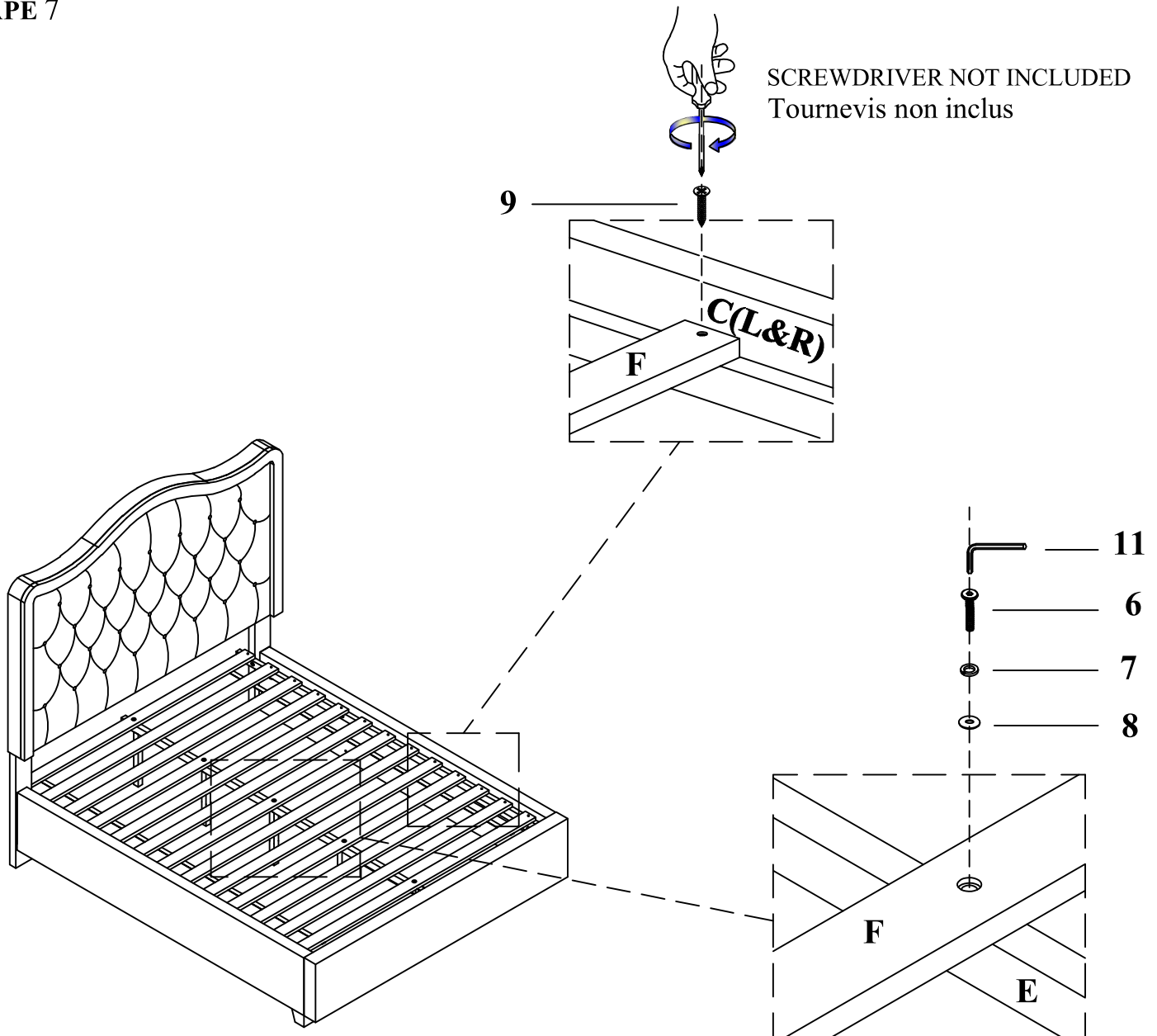

Completed