

















# ASSEMBLY INSTRUCTION



ITEM NO: 1604F-1 FULL BED HB  
 1604F-2 FULL BED FB & SLATS  
 1604F-3 FULL BED RAILS

**Thank you for purchasing this quality product. Be sure to check all packing material carefully for small parts that may have come loose inside the carton during shipment.**

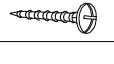
PART LIST			
NO.	Description	Sketch	Q'ty
A	HEADBOARD		1PC
B-1	HEADBOARD LEG(LSF)		1PC
B-2	HEADBOARD LEG(RSF)		1PC
C	FOOTBOARD		1PC
D	FOOTBOARD LEG		2PCS
E	SIDE RAILS		2PCS
F	SUPPORT LEGS		4PCS
G	SLAT		4PCS

HARDWARE LIST (PUT IN 1604F-1 CARTON)				
NO.	Description	Sketch	Size	Q'ty
1	BOLT		Ø5/16"*18*2 1/4"	6PCS
2	SPRING WASHER		Ø5/16"*12D*1.1mm	6PCS
3	FLAT WASHER		Ø5/16"*19D*2mm	6PCS
4	ALLEN KEY		1/6"	1PC

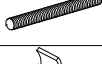
HARDWARE LIST (PUT IN 1604F-2 CARTON)				
NO.	Description	Sketch	Size	Q'ty
5	BOLT		5/16"*18*3/4 "	6PCS
6	SPRING WASHER		Ø5/16"*12D*1.1mm	6PCS
7	FLAT WASHER		Ø5/16"*19D*2mm	6PCS
8	SCREW		5/32"*1 1/4"	8PCS
4	ALLEN KEY		1/6"	1PC

HARDWARE LIST (PUT IN 1604F-3 CARTON)				
NO.	Description	Sketch	Size	Q'ty
9	Thread Bolt		Ø5/16"*100mm	8PCS
10	Hex Nut		Ø5/16"*23mm	8PCS
11	Wrench		12mm	1PC

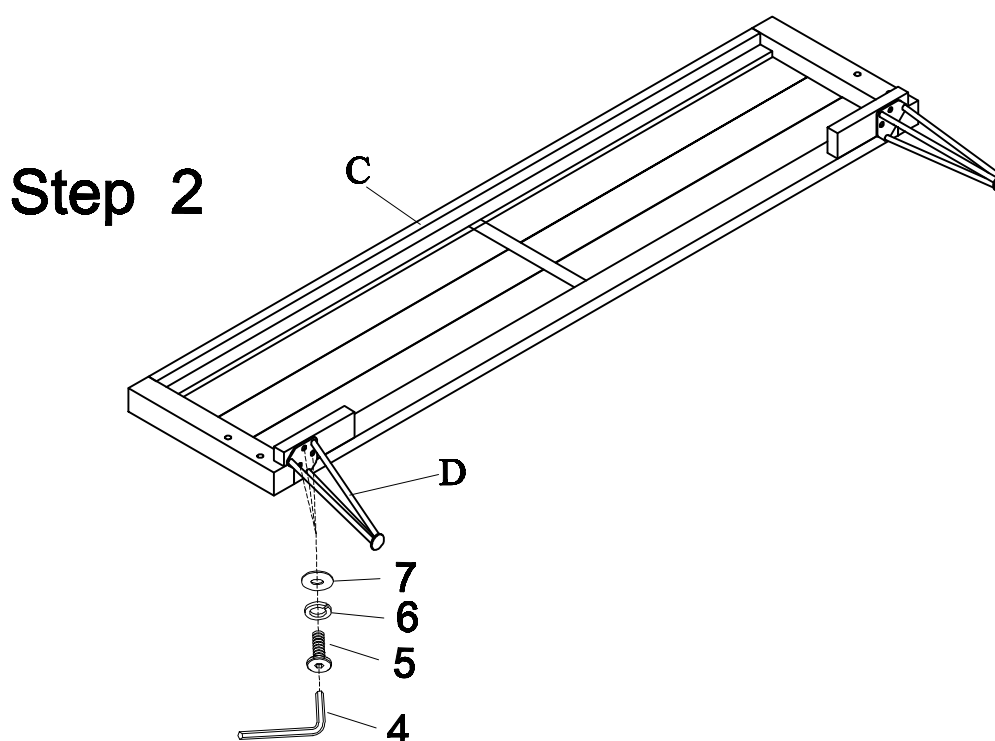
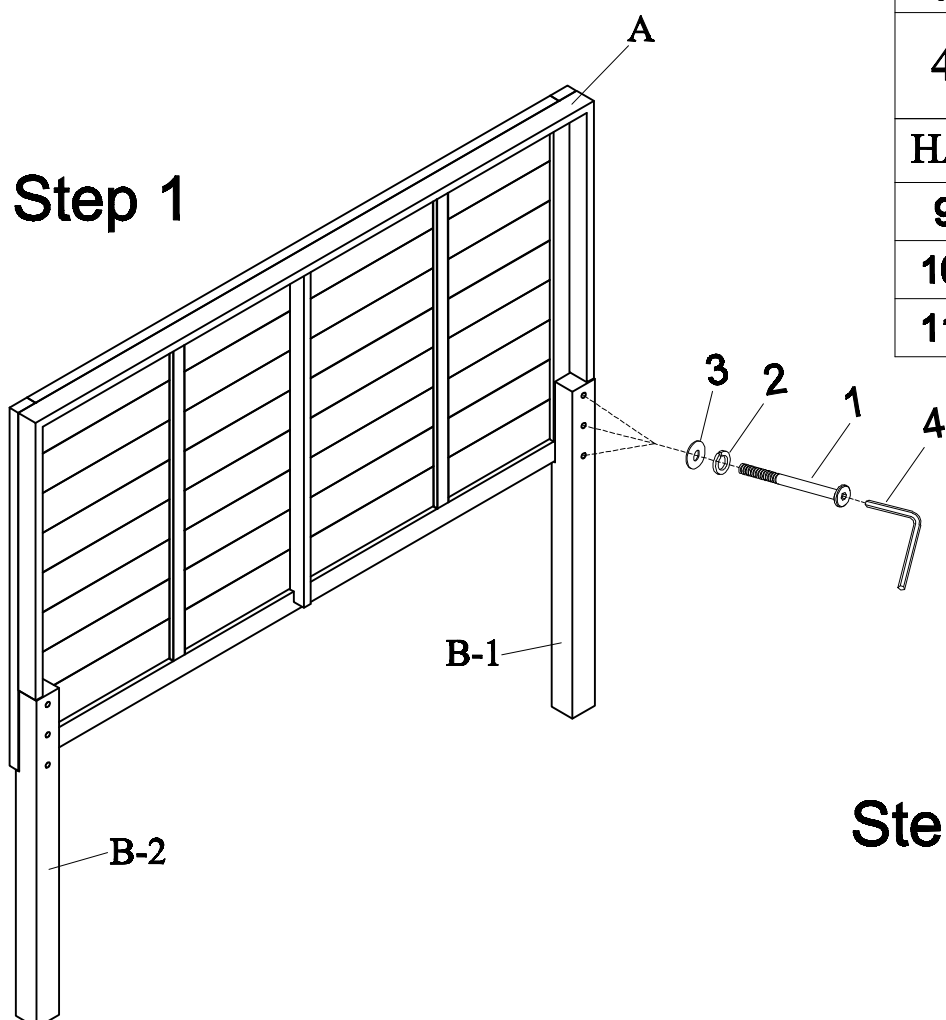

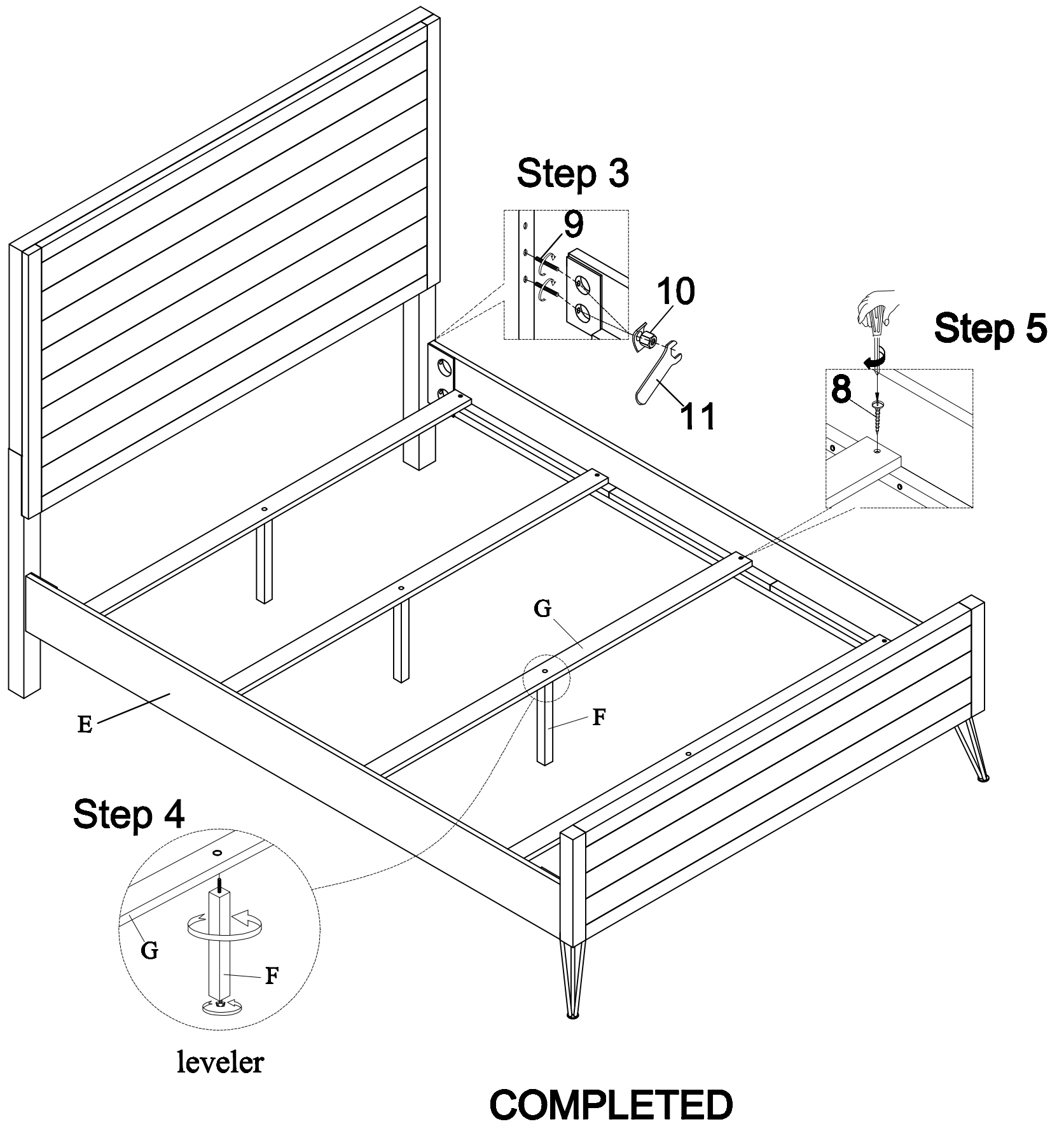

 It is recommended to install protective pads under all legs and supports to avoid damage or scratches when placing furniture on a wood floor or other hard surface, and to limit indentation and prevent discoloration if placing on carpet.

 Il est recommandé de placer des coussins protecteurs sous tous les pieds et toutes les bases des meubles pour éviter d'endommager ou d'égratigner les planchers en bois ou autres surfaces dures, et pour limiter l'empreinte et empêcher la décoloration quand les meubles reposent sur la moquette.

**MADE IN VIETNAM**