





















# Assembly Instruction

ITEM#: 1468K CALIFORNIA/EASTERN KING BED  
 1468K-1 ( 1/4 ) CALIFORNIA/EASTERN KING HEADBOARD  
 1468K-2 ( 2/4 ) CALIFORNIA/EASTERN KING FOOTBOARD & SLATS  
 1468K-3CK ( 3/4 ) CALIFORNIA KING SIDE RAILS  
 1468-3 ( 3/4 ) EASTERN KING /QUEEN SIDE RAILS  
 1468-P ( 4/4 ) KING /QUEEN HEADBOARD POSTS

## PART LIST

1		HEADBOARD PANEL	1 PC
2		HEADBOARD LSF POST	1 PC
3		HEADBOARD RSF POST	1 PC
4		HEADBOARD CROSS BAR	1 PC
5		FOOTBOARD	1 PC
6		FOOTBOARD TOP FINIAL	2 PCS
7		FOOTBOARD BUN FOOT	2 PCS
8		SIDE RAIL	2 PCS
9		SLAT	4 PCS
10		SUPPORT LEG	8 PCS

## HARDWARE LIST IN-1K

A		ALLEN KEY 5/16"	1 PC
B		BOLT 5/16"x1-3/4"	10 PCS
C		SPRING WASHER 5/16"	10 PCS
D		FLAT WASHER 5/16"	10 PCS
E		BOLT 5/16" x 3-1/4"	8 PCS
F		"C" WASHER 5/16"	8 PCS
G		HEX NUT 5/16"	8PCS
H		WRENCH 13x90MM	1 PC
I		WOOD SCREW #8 x 32MM	8 PCS

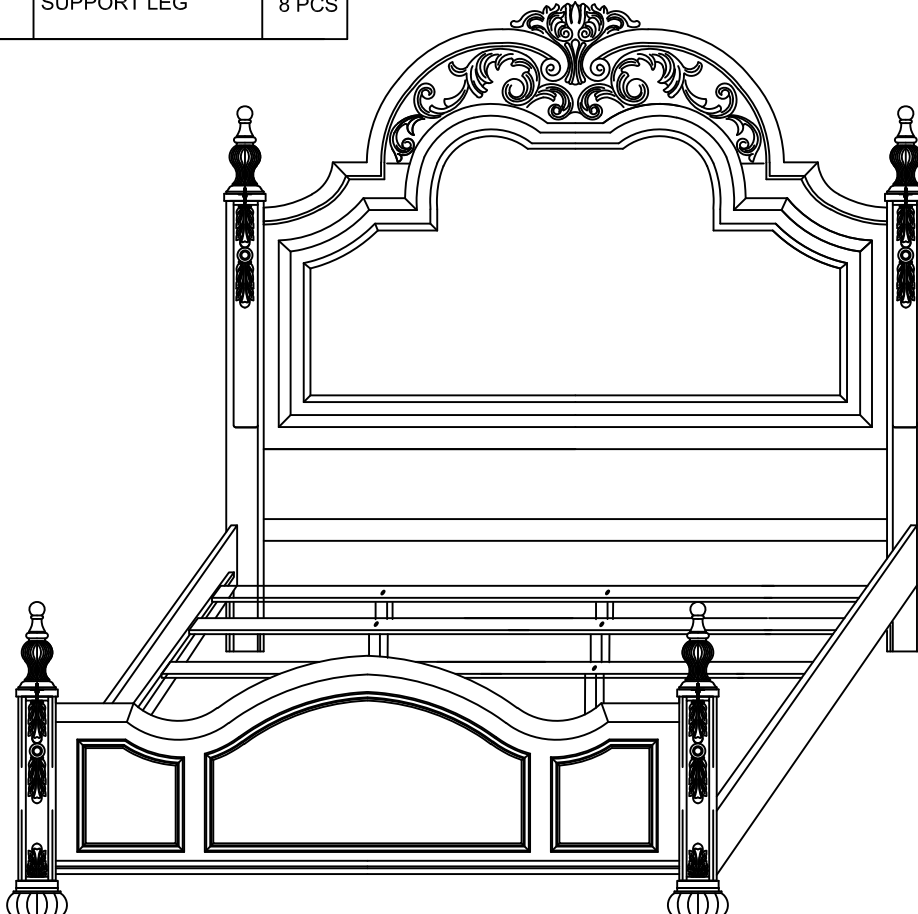



# Assembly Instruction

ITEM#: 1468K CALIFORNIA/EASTERN KING BED  
 1468K-1 (1/4) CALIFORNIA/EASTERN KING HEADBOARD  
 1468K-2 (2/4) CALIFORNIA/EASTERN KING FOOTBOARD & SLATS  
 1468K-3CK (3/4) CALIFORNIA KING SIDE RAILS  
 1468-3 (3/4) EASTERN KING /QUEEN SIDE RAILS  
 1468-P (4/4) KING /QUEEN HEADBOARD POSTS

STEP 1

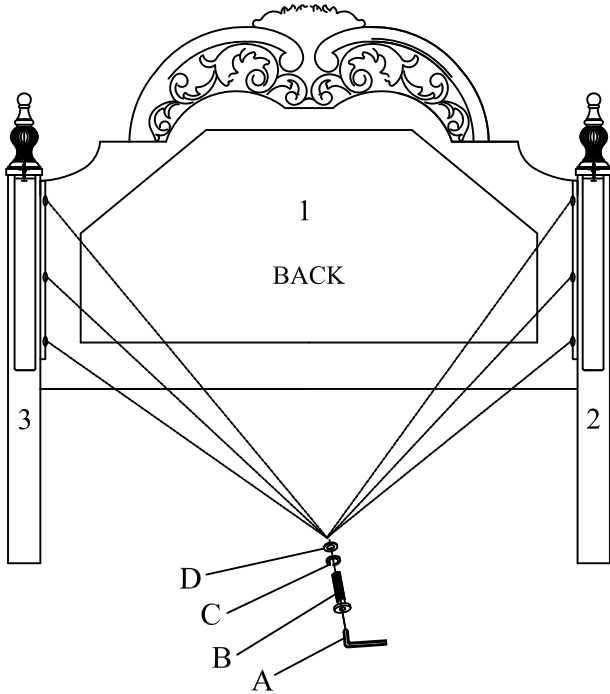

STEP 2

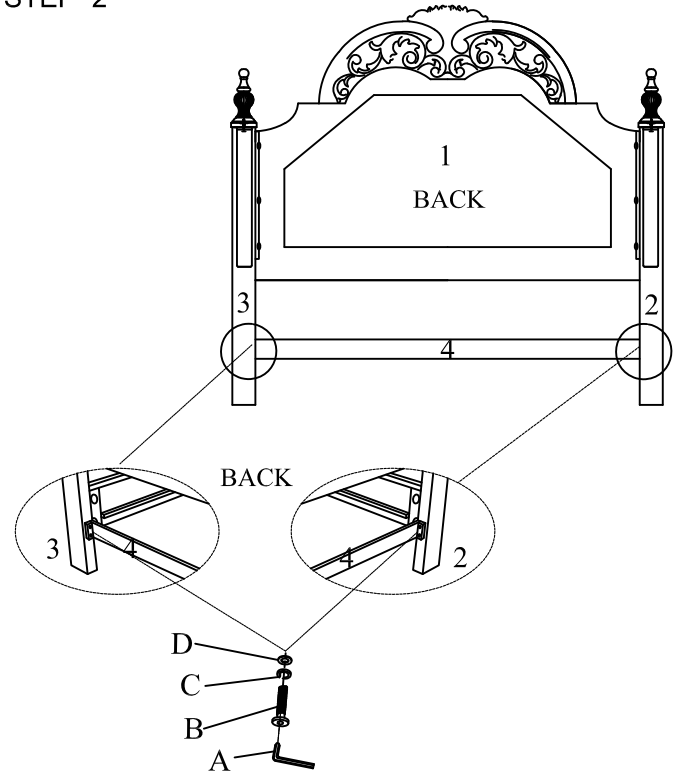

STEP 3

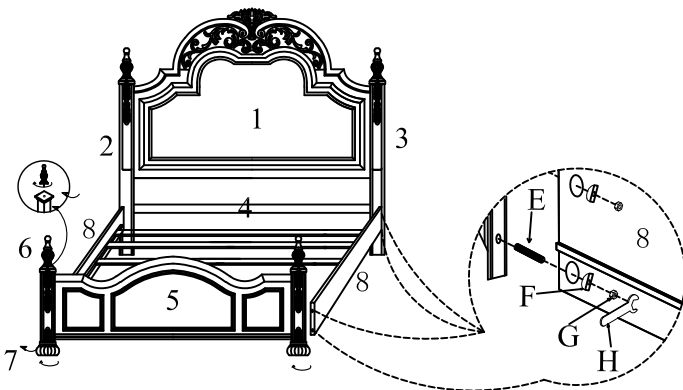

STEP 4

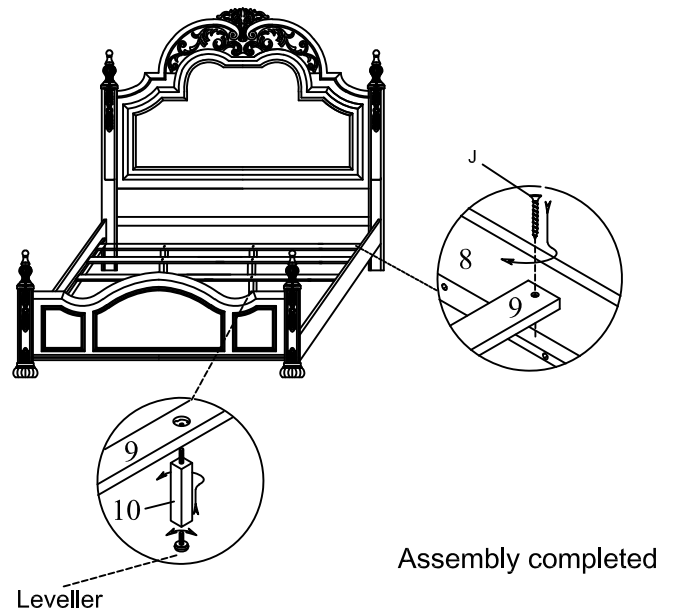

NOTE: Fasten the bolts after alignment for the bottom line of the footboard to the side rails.

Assembly completed



- For items use on wooden floor hard surfaces or carpets. It is recommended to install protective pads under all legs and supports to avoid/prevent from damages/scratches and discoloration.
- Hardware may loosen over time. Periodically check to make sure all connections are tight. Re-tight if necessary.