

# ASSEMBLY INSTRUCTION

ITEM NO: 1458K - 1 KING HEADBOARD  
 1458K - 2 KING FOOTBOARD & SLATS  
 1458- 3 KING QUEEN SIDE RAILS











Thank you for purchasing this quality product. Be sure to check all packing material carefully for small parts that may have come loose inside the carton during shipment.

**TOOLS REQUIRED (NOT PROVIDED)**







PHILLIPS SCREWDRIVER



**HARDWARE LISTS**

NO.	Description	Sketch	Size	Q'ty
<b>HARDWARE (PACK IN - 1)</b>				
1	BOLT		5/16"*44mm	6PCS
2	SPRING WASHER		5/16"	6PCS
3	FLAT WASHER		5/16"*19mm	6PCS
4	ALLEN KEY		4mm	1PC
<b>HARDWARE (PACK IN - 3)</b>				
5	SCREW		Ø8*32mm	8PCS
6	THREADED BOLT		5/16"*88mm	8PCS
7	HEX NUT		5/16"	8PCS
8	U-SQUARE FLAT WASHER		5/16"	8PCS
9	SPRING WASHER		5/16"	8PCS
10	WRENCH		90*12mm	1PC

**PART LIST**

NO.	Description	Sketch	Q'ty
A	HEADBOARD		1PC
B	HEADBOARD POST (RSF)		1PC
C	HEADBOARD POST (LSF)		1PC
D	FOOTBOARD		1PC
E	SIDE RAIL		2PCS
F	SLAT ROLL		4PCS
G	SUPPORT LEG		8PCS

Step 1:

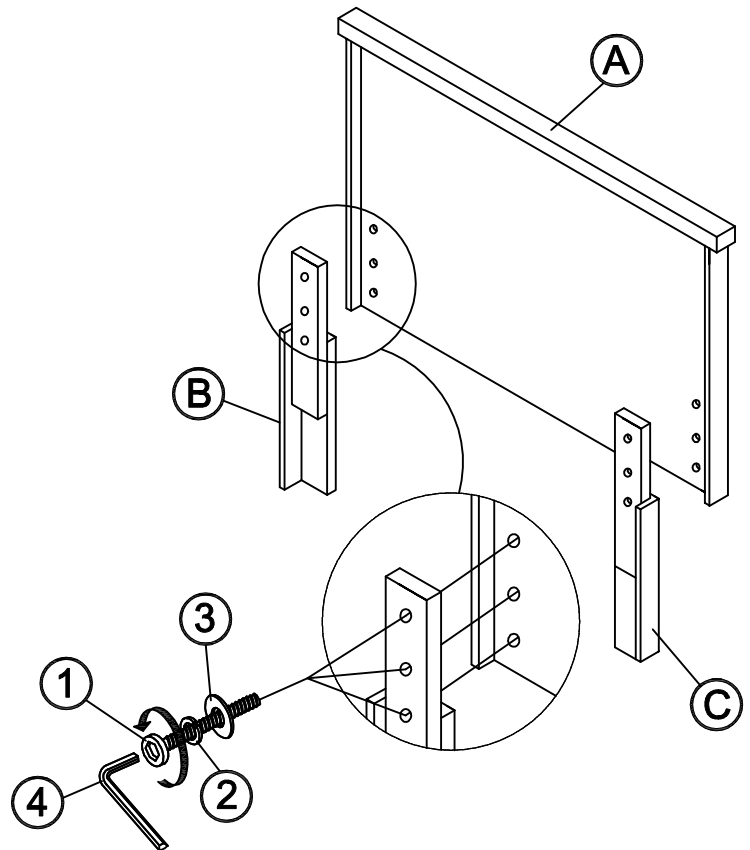
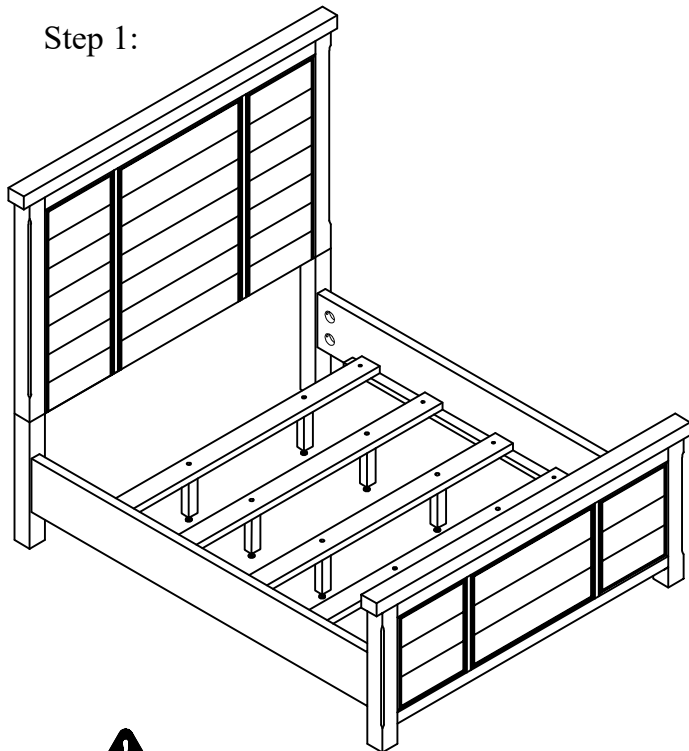

It is recommended to install protective pads under all legs and supports to avoid damage or scratches when placing furniture on a wood floor or other hard surface, and to limit indentation and prevent discoloration if placing on carpet.

Hardware may loosen over time . Periodically check to make sure all connections are tight. Re-tighten if necessary

**MADE IN VIETNAM**

# ASSEMBLY INSTRUCTION

ITEM NO: 1458K - 1 KING HEADBOARD  
 1458K - 2 KING FOOTBOARD & SLATS  
 1458- 3 KING QUEEN SIDE RAILS

Thank you for purchasing this quality product. Be sure to check all packing material carefully for small parts that may have come loose inside the carton during shipment.

Step 2:

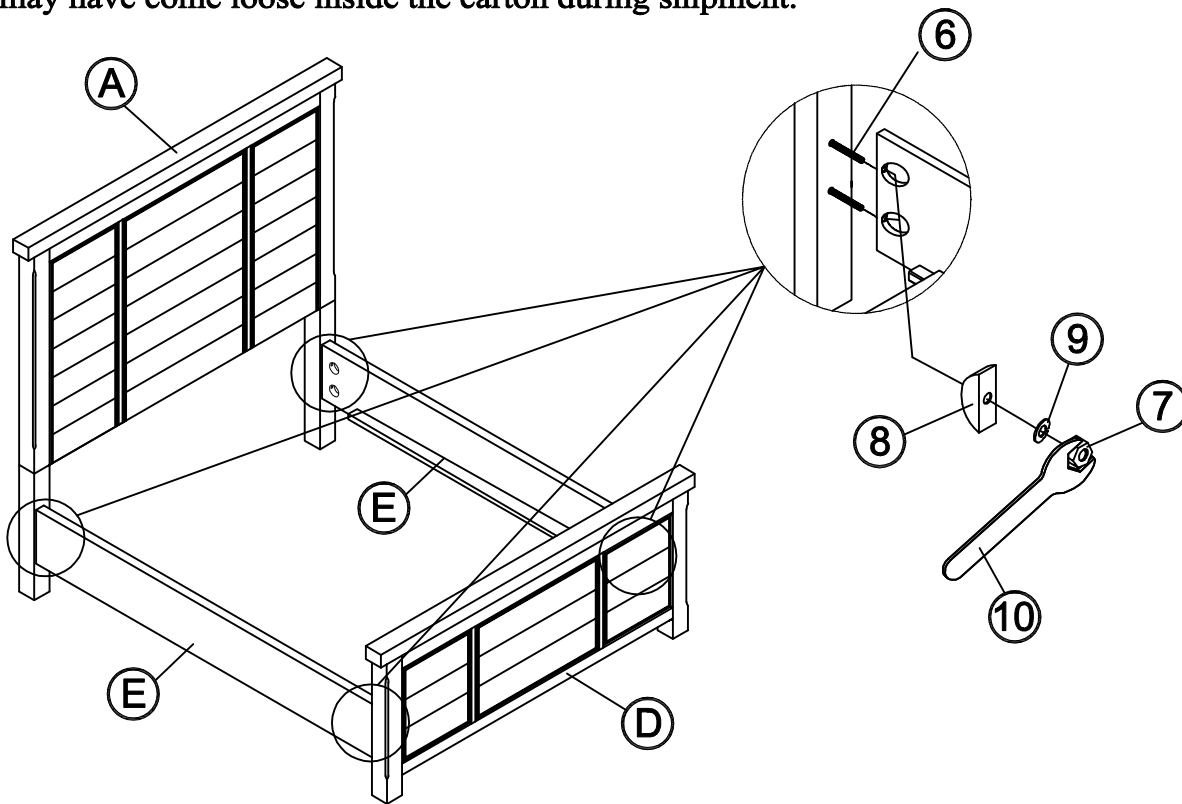

Step 3:

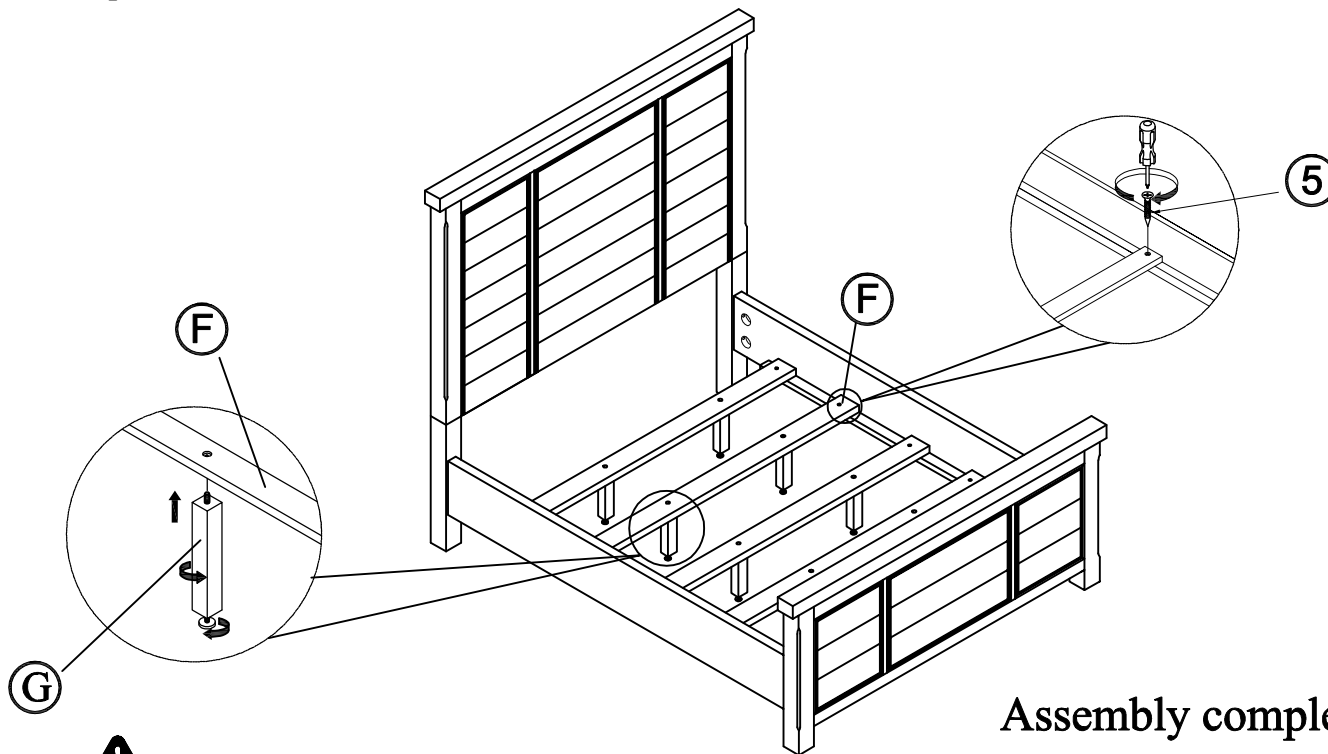

Assembly completed



It is recommended to install protective pads under all legs and supports to avoid damage or scratches when placing furniture on a wood floor or other hard surface, and to limit indentation and prevent discoloration if placing on carpet.  
 Hardware may loosen over time . Periodically check to make sure all connections are tight. Re-tighten if necessary