



## Assembly Instruction Swivel Chair





ITEM NO.: 1025DGY/TPE/DTL/GRN-1

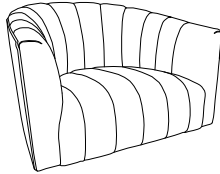

Swivel base is located on the chair seat, hardware set is located inside the carton for assembly.

**Note: Do not use power tools for assembly. Power tools increase the risk of over tightening which lead to splitting or cracking the wood. Do not tighten bolts until completely assembled.**

### Component list

No	Drawing	Qty	Description
A		1	<b>Swivel Chair Seat</b>
B		1	<b>Swivel Base</b>
C		4	<b>Bolts 1/4"*25mm</b>
D		4	<b>Flat Washers Ø19*Ø6*1.5mm</b>
E		4	<b>Lock Washers 1/4"*1.3mm</b>
F		1	<b>Allen Wrench M5*70*35mm</b>

## Step #1

Hardware package on the inner wall of the carton.

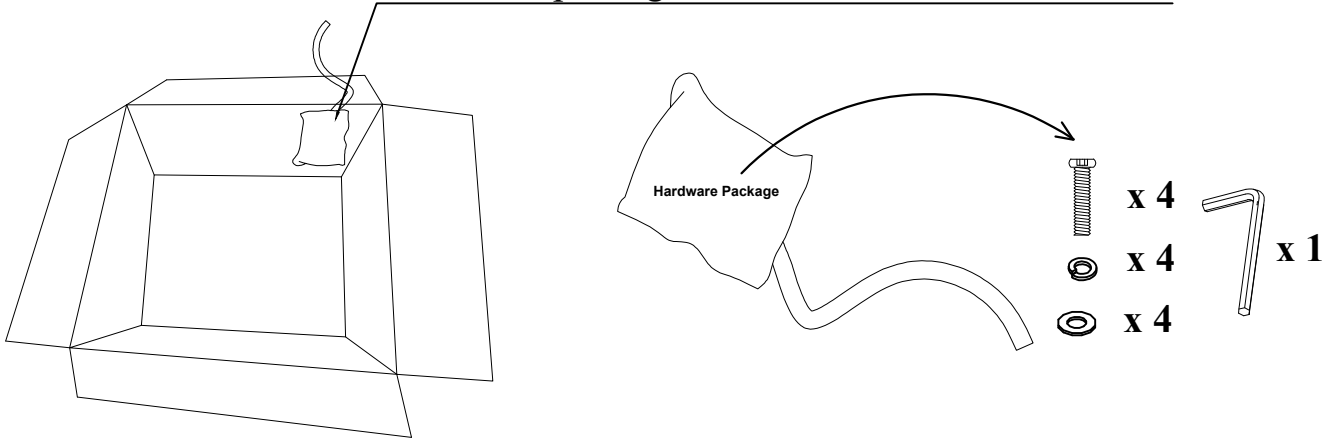

## Step #2

Swivel base on swivel chair seat.

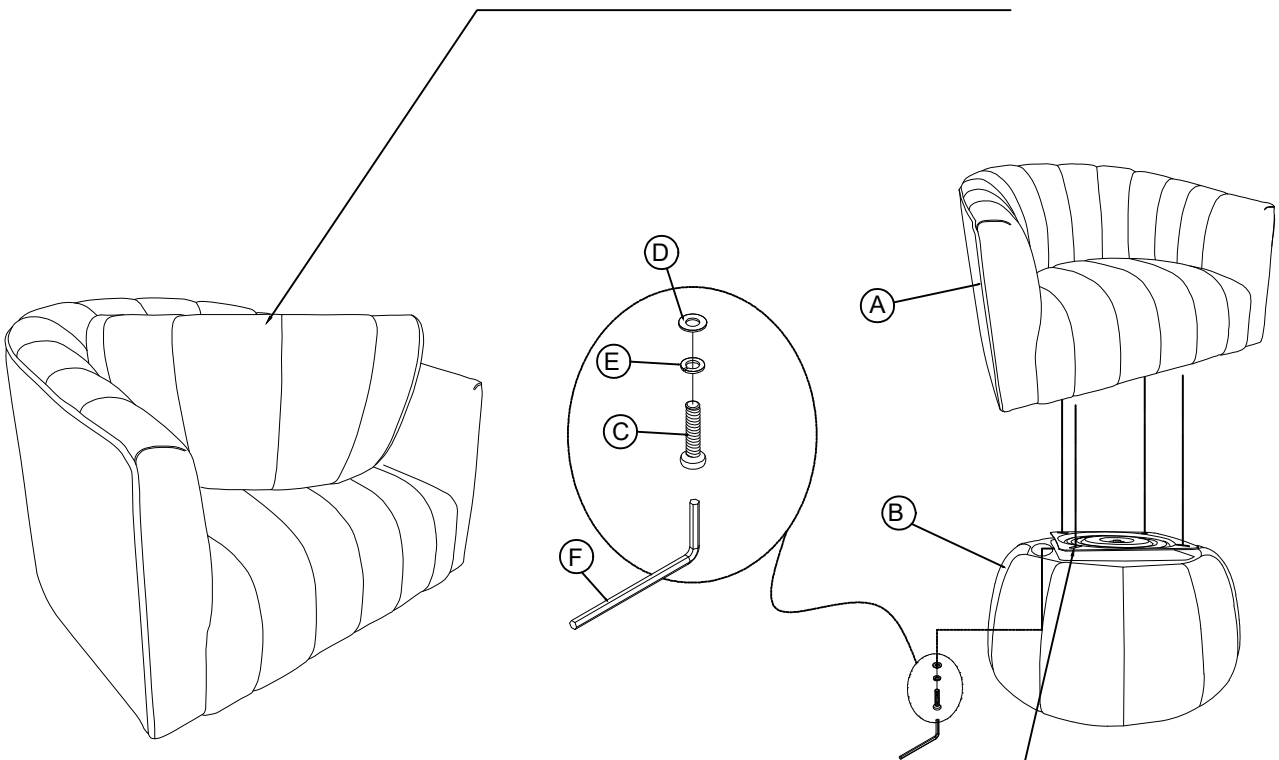

Assemble the first two bolts, then rotate the swivel base 90° and install the remaining two bolts.

### Step #3

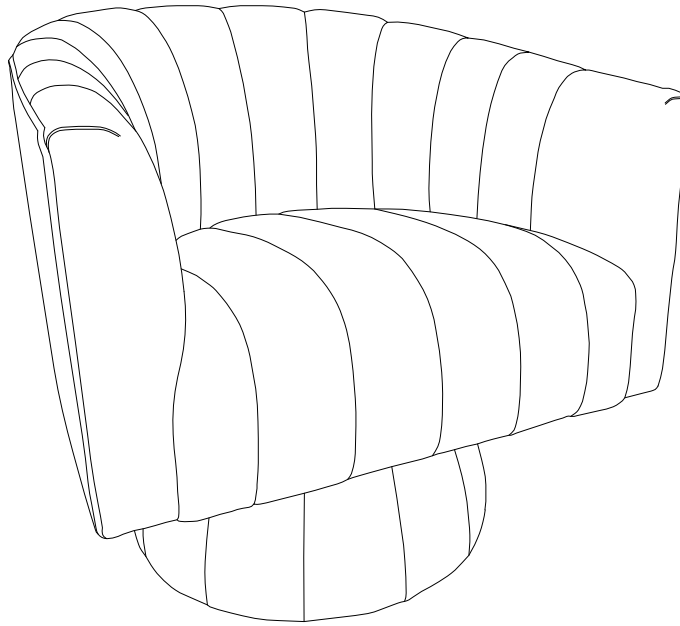

## Care Instruction for Velvet Furniture:

In order to maintain the original appearance of your velvet Furniture, please follow below simple care procedures:

- Avoid exposing furniture directly to sunlight or heating and air conditioning outlets. Sunlight and or exposure to heating and air conditioning outlets will fade/damage velvet.
- Vacuum or wipe with a soft cloth to remove dust.
- Hardware may loosen over time. Periodically check to make sure all connection are tight, Re-tighten if necessary



For items use on wooden floor, hard surfaces or carpets, it is recommended to Install protective pads under all legs and supports to avoid/prevent from damages/scratches and discoloration.