

ASSEMBLING INSTRUCTIONS







ITEMNO: 9214GY-2 Love seat



Legs and hardware are stored in the bottom of the seat.
Please take out for assembly.

Note: Do not use power tools for assembly. Power tools increase the risk of over tightening which lead to splitting or cracking the wood.

COMPONENT LIST

NO.	DRAWING	QTY	DESCRIPTION	NO.	DRAWING	QTY	DESCRIPTION
A		1 PC	SEAT	E		2 PCS	PILLOW
B		1 PC	BACK REST	F		4 PCS	PLASTIC LEG
C		1 PC	RSF BACK CUSHION	G		4 PCS	GASKETS
D		1 PC	LSF BACK CUSHION				

step #1

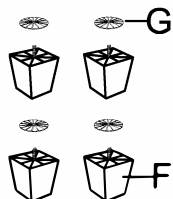
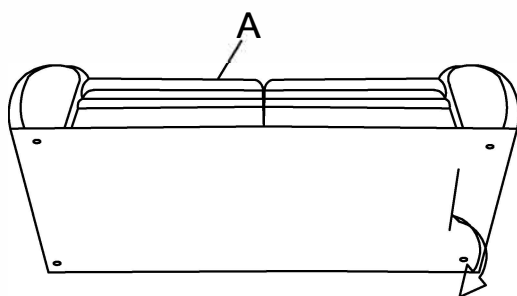

step #2

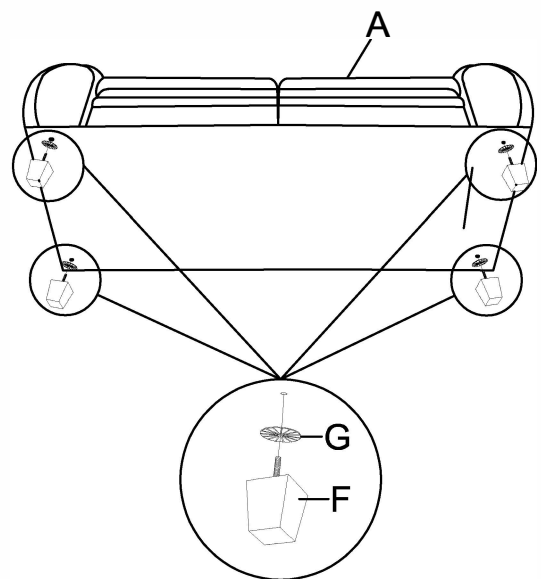



ASSEMBLING INSTRUCTIONS

ITEM NO: 9214GY-2 Loveseat

step #3

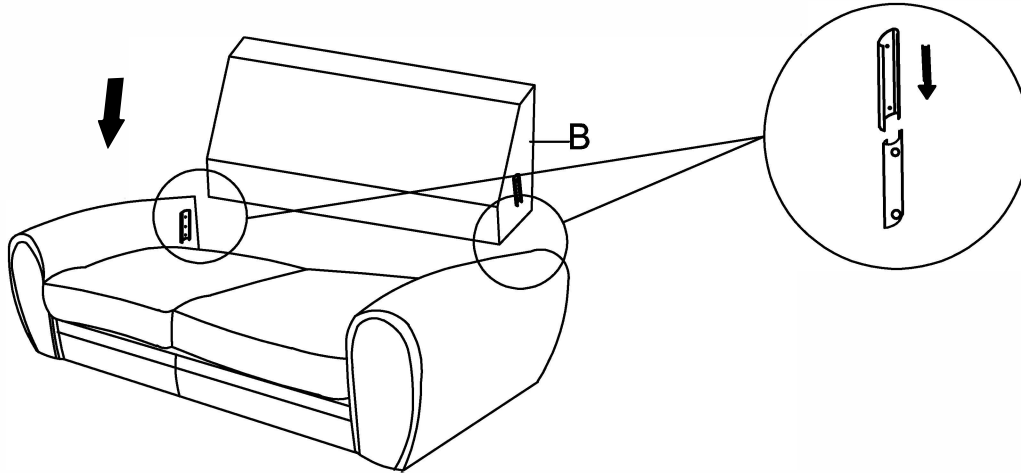

step #4

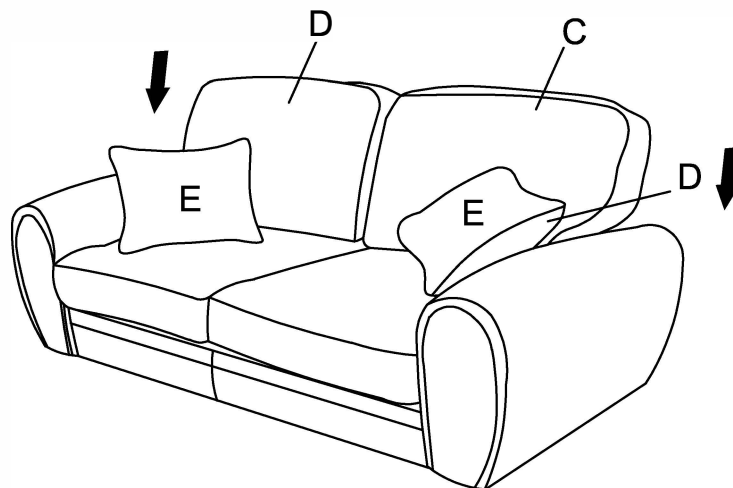

Care Instruction for Chenille Furniture:

In order to maintain the original appearance of your

please follow below simple care procedures: Chenille Furniture.

- Avoid exposing furniture directly to sunlight or heating and air conditioning outlets. Sunlight and or exposure to heating and air conditioning outlets will fade/damage Chenille Furniture.
- Vacuum or wipe with a soft cloth to remove dust.



For items use on wooden floor, hard surfaces or carpets, it is recommended to Install protective pads under all legs and supports to avoid/prevent from damages/scratches and discoloration.