

# ASSEMBLY INSTRUCTIONS

ITEM NO.: 8548/8548BE-2ACL Armless Convertible 2-Seater with Pull-out Bed and Click Motion Back  
 8548/8548BE-2A Armless 2-Seater  
 8548/8548BE-CR Corner Seat  
 8548/8548BE-AC Armless Chair  
 8548/8548BE-VCCL Armless Convertible Storage Chaise with Click Motion Back  
 8548/8548BE-A Two Arms  
 8548/8548BE-OT Storage Ottoman with Casters  
 8548/8548BE-ACCL Convertible Armless Chair with Pull-out Bed and Click Motion Back  
 8548/8548BE-15ACL Convertible Armless Chair and Half with Pull-out Bed and Click Motion Back  
 8548/8548BE- A4 Two Roll Arms  
 8548/8548BE- A2 Two Bookshelf Arms with Charging ports

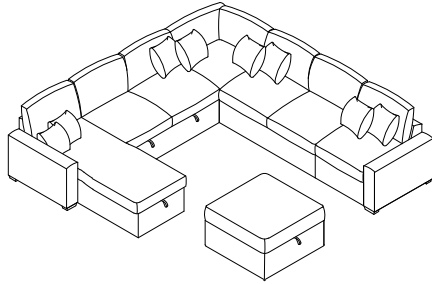
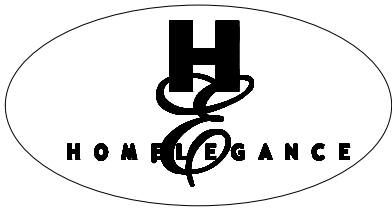

Thank you for purchasing this product. Please take time to read and follow the instructions below. Check that you have all parts and hardware before assembly. Parts apparently missing are often found in the packing materials. If you do not have all the parts listed, have your dealer contact us and they be sent to you immediately.

It is recommended to install protective pads under all legs and support to avoid damage or scratches when placing furniture on a wood floor or other hard surface, and to limit Indentation and prevent discoloration if placing on carpet.

## 8548-2ACL PARTS LISTS

NO.	SKETCH	DESCRIPTION	QTY
A		Seat	1 PC
B		Back Cushion	2 PCS
C		Pillow 20"x20"	1 PC
D		Pillow 18"x18"	1 PC

## 8548-2A PARTS LISTS





NO.	SKETCH	DESCRIPTION	QTY
E		Seat	1 PC
F		Backrest	1 PC
B		Back Cushion	2 PCS
C		Pillow 20"x20"	1 PC
D		Pillow 18"x18"	1 PC



## 8548-CR PARTS LISTS



NO.	SKETCH	DESCRIPTION	QTY
G		Seat	1 PC
H		Small Back Cushion	1 PC
I		Big Back Cushion	1 PC
C		Pillow 20"x20"	1 PC
D		Pillow 18"x18"	1 PC



## 8548-AC PARTS LISTS



NO.	SKETCH	DESCRIPTION	QTY
J		Seat	1 PC
K		Backrest	1 PC
B		Back Cushion	1 PC





8548-VCCL PARTS LISTS			
NO.	SKETCH	DESCRIPTION	QTY
L		Seat	1 PC
B		Back Cushion	1 PC
C		Pillow 20"x20"	1 PC
D		Pillow 18"x18"	1 PC

8548-A PARTS LISTS			
NO.	SKETCH	DESCRIPTION	QTY
M		LSF Arm	1 PC
N		RSF Arm	1 PC

8548-A4 PARTS LISTS			
NO.	SKETCH	DESCRIPTION	QTY
R		LSF Arm	1 PC
S		RSF Arm	1 PC

8548-A2 PARTS LISTS			
NO.	SKETCH	DESCRIPTION	QTY
T		LSF Arm	1 PC
U		RSF Arm	1 PC
V		Adaptor	2 PCS

8548-ACCL PARTS LISTS			
NO.	SKETCH	DESCRIPTION	QTY
P		Seat	1 PC
B		Back Cushion	1 PC

8548-15ACL PARTS LISTS			
NO.	SKETCH	DESCRIPTION	QTY
Q		Seat	1 PC
B		Back Cushion	1 PC
C		Pillow 20"x20"	1 PC
D		Pillow 18"x18"	1 PC

8548-OT PARTS LISTS			
NO.	SKETCH	DESCRIPTION	QTY
O		Ottoman	1 PC

STEP 1: -2A

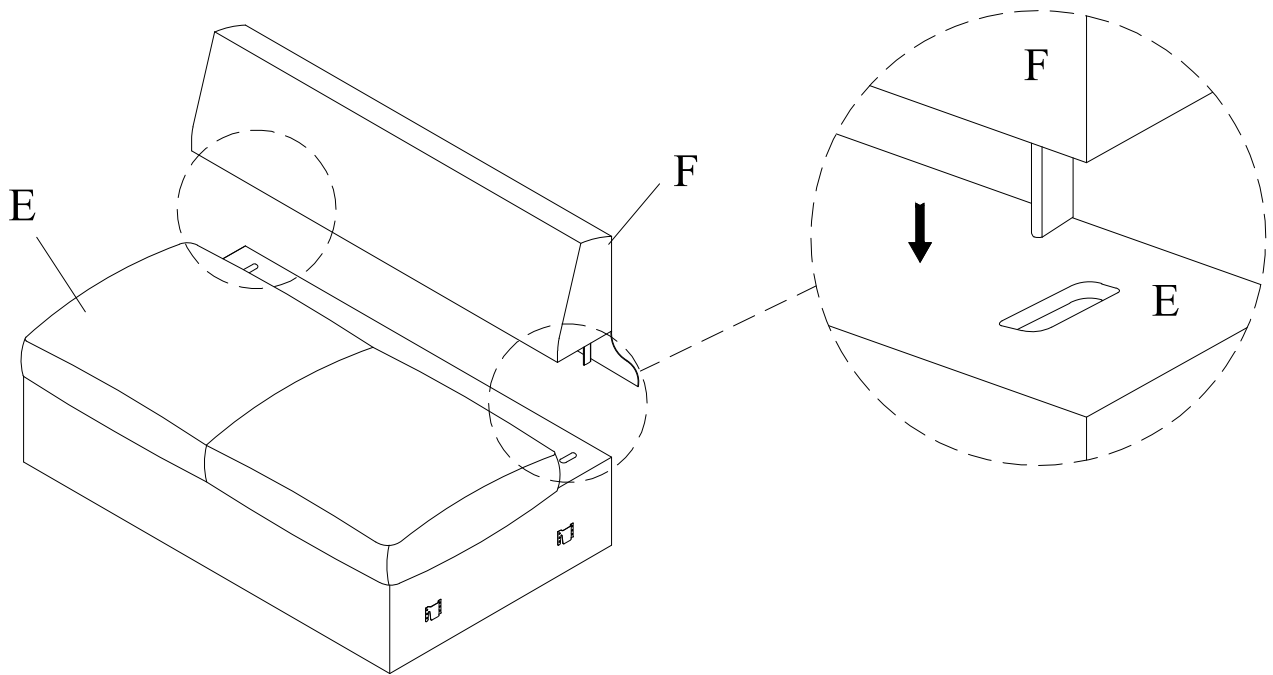

STEP 2: -AC

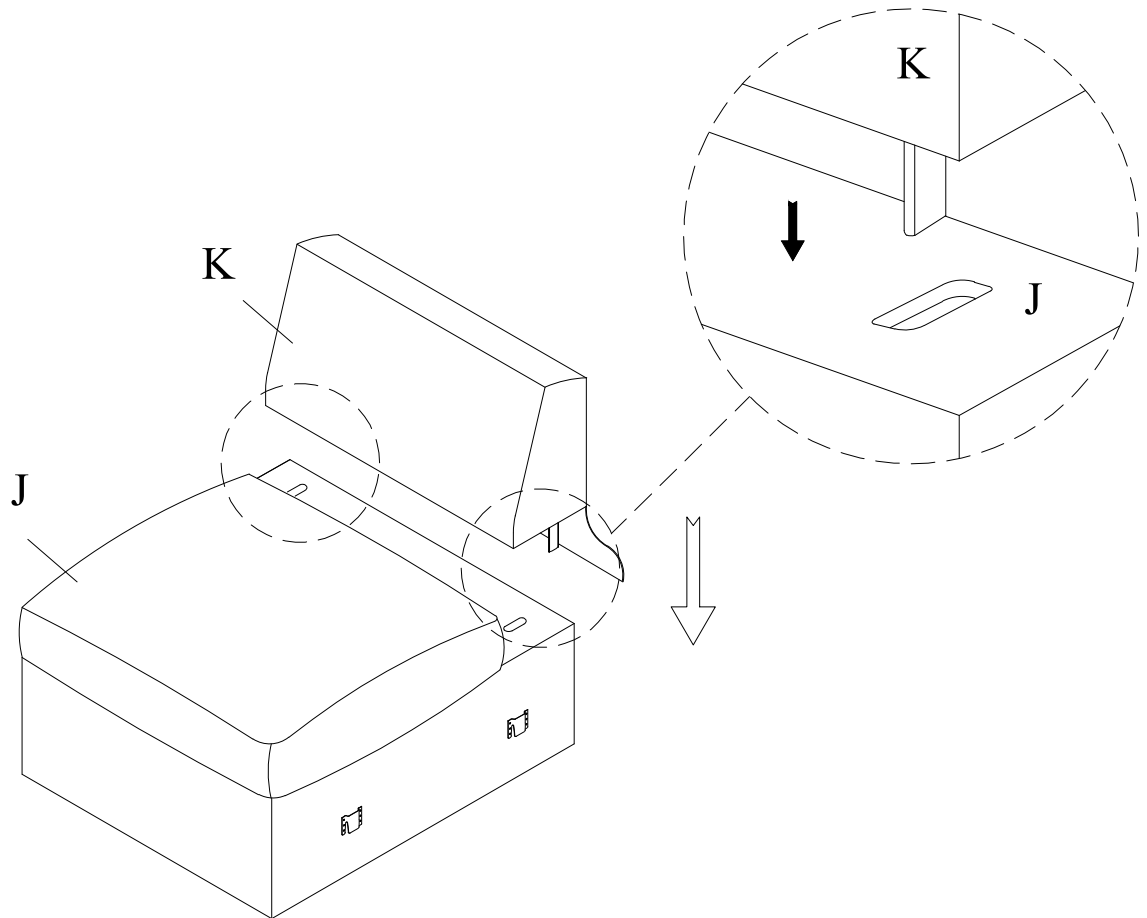

STEP 3: -AC +A(N)/ A4 (S) / A2 (U)

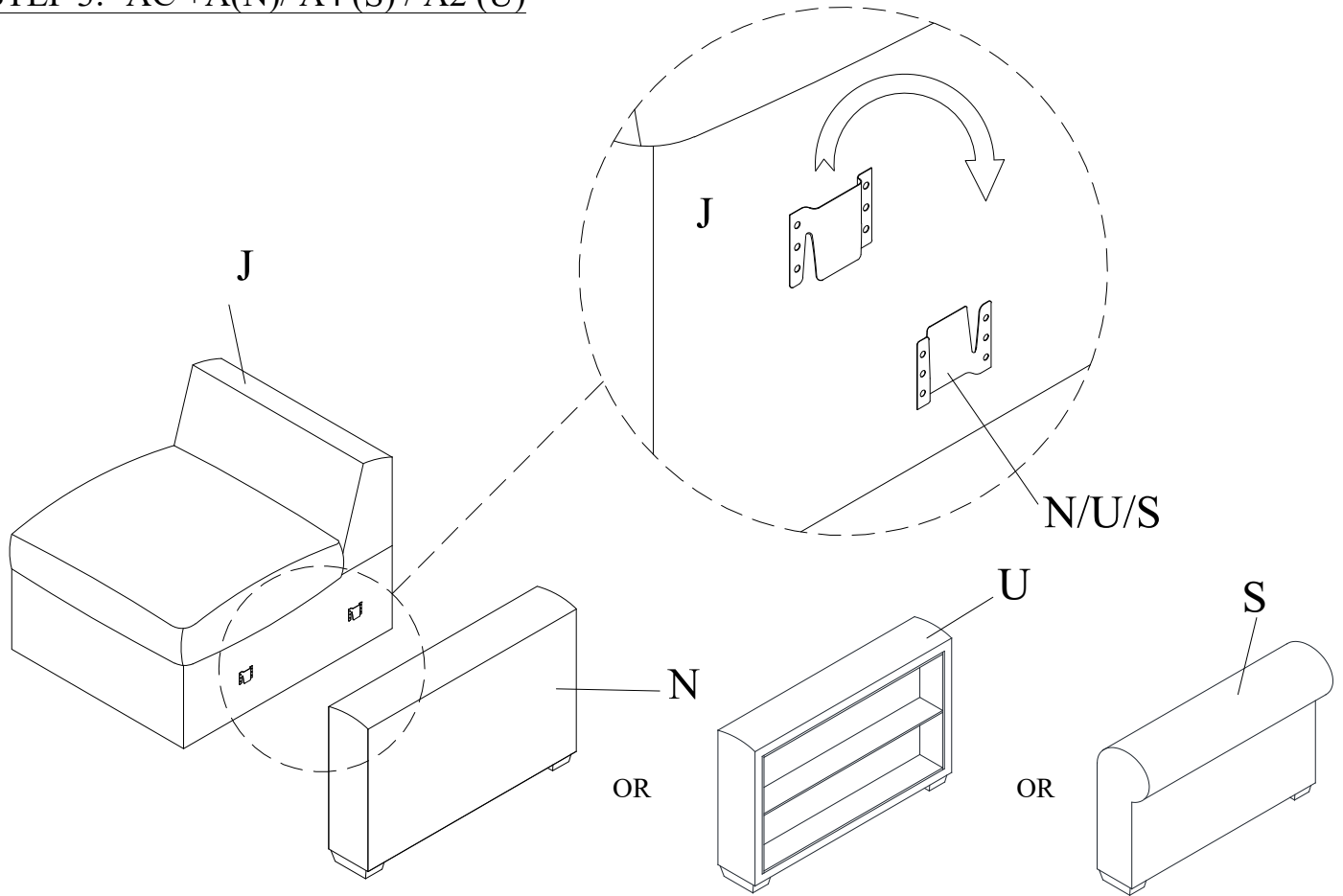

STEP 4: -VCCL +A(M)/ A4 (R) / A2 (T)

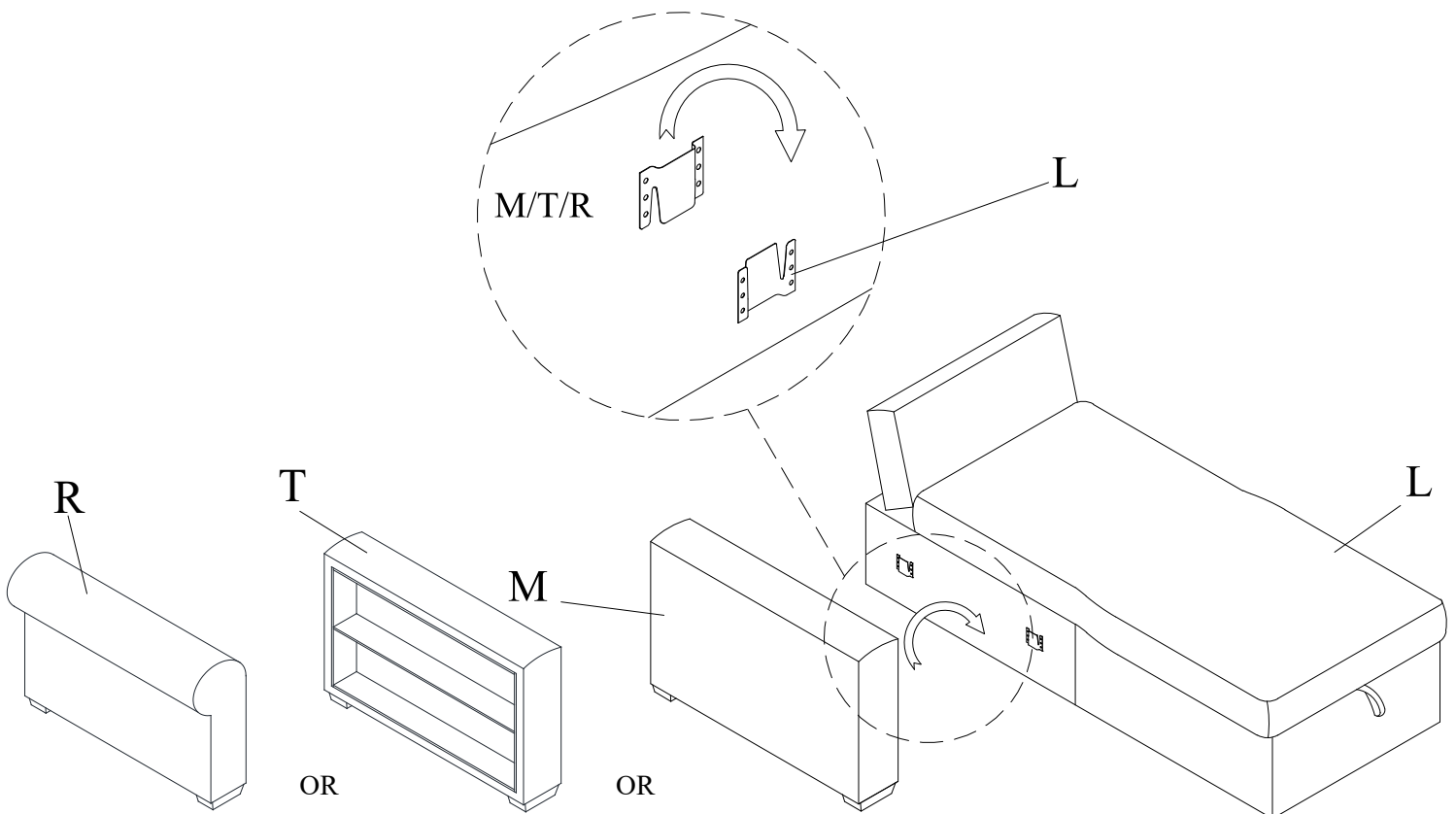

STEP 5: -2ACL+CR+2A

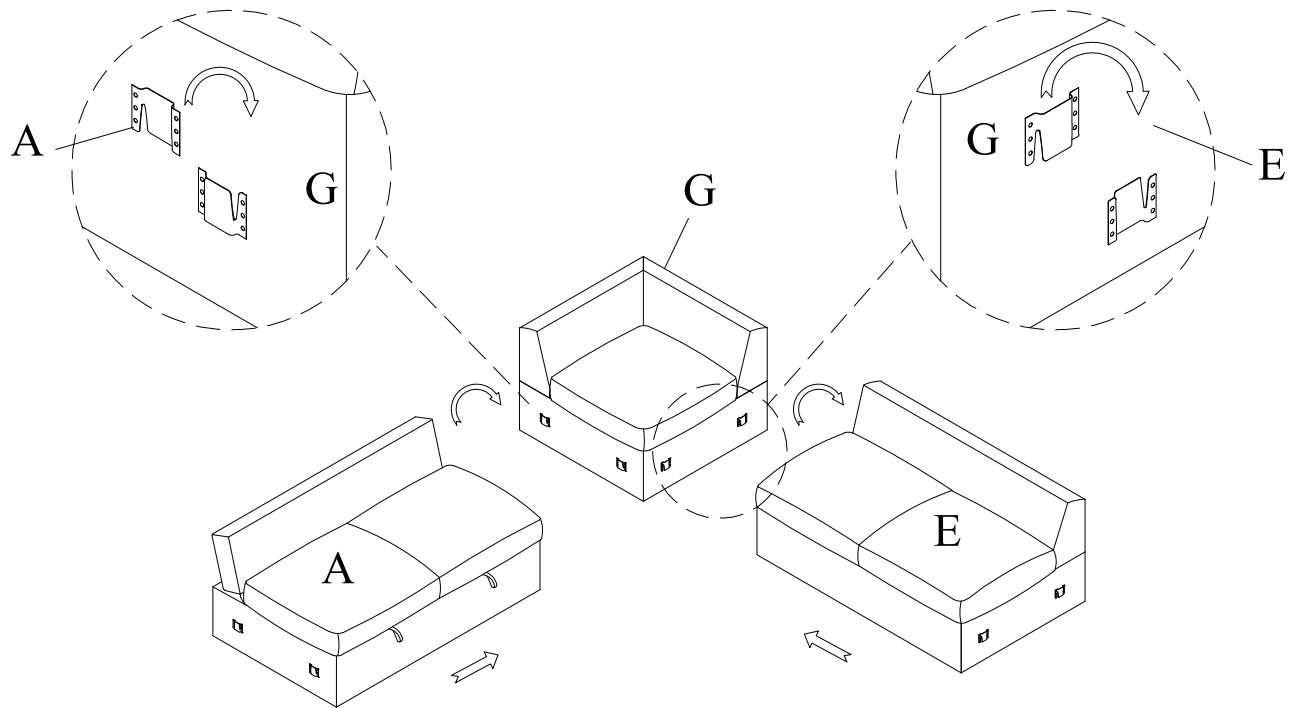

STEP 6: -2ACL+CR+2A+AC

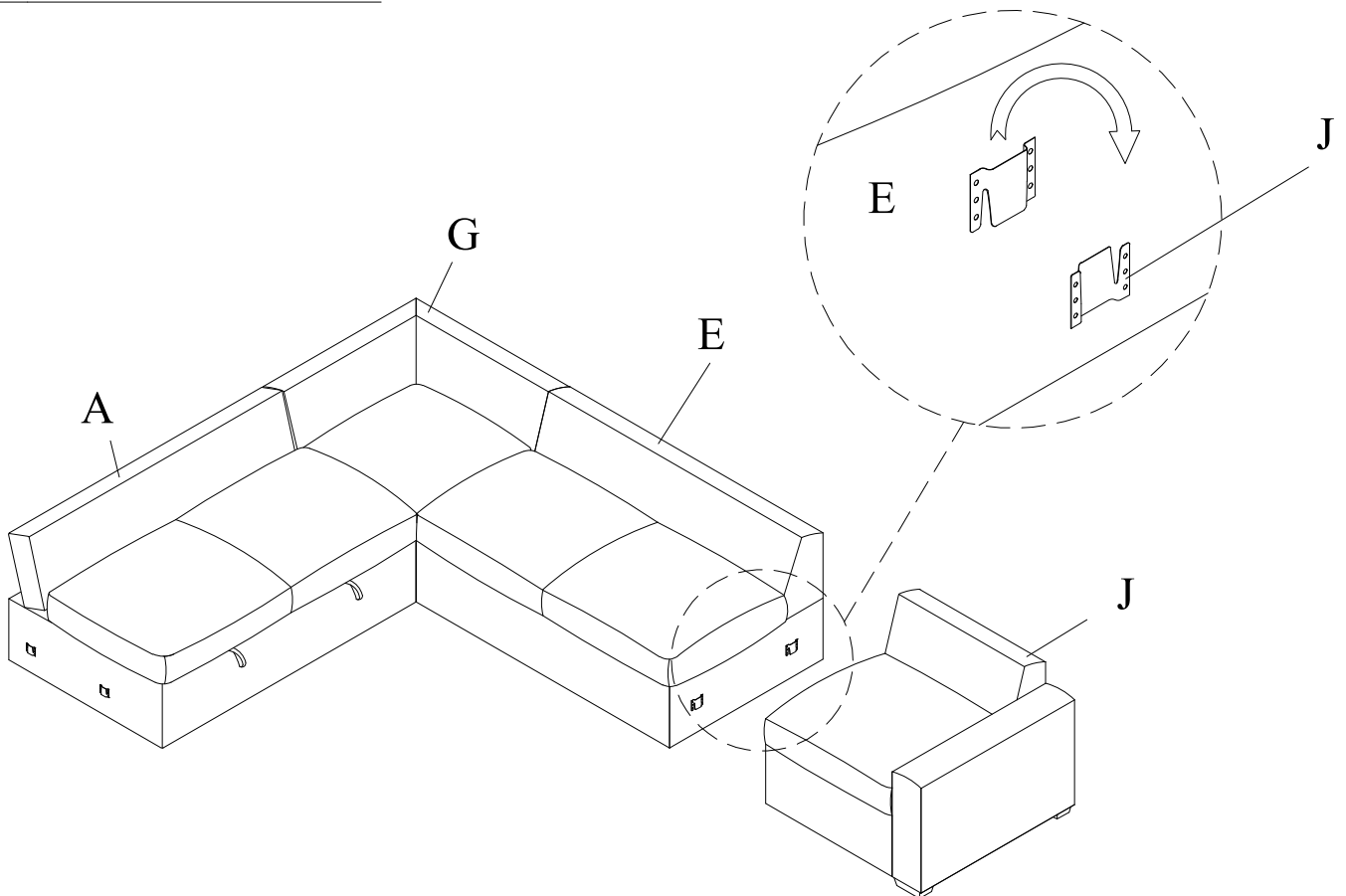

STEP 7: -VCCL+2ACL+CR+2A+AC

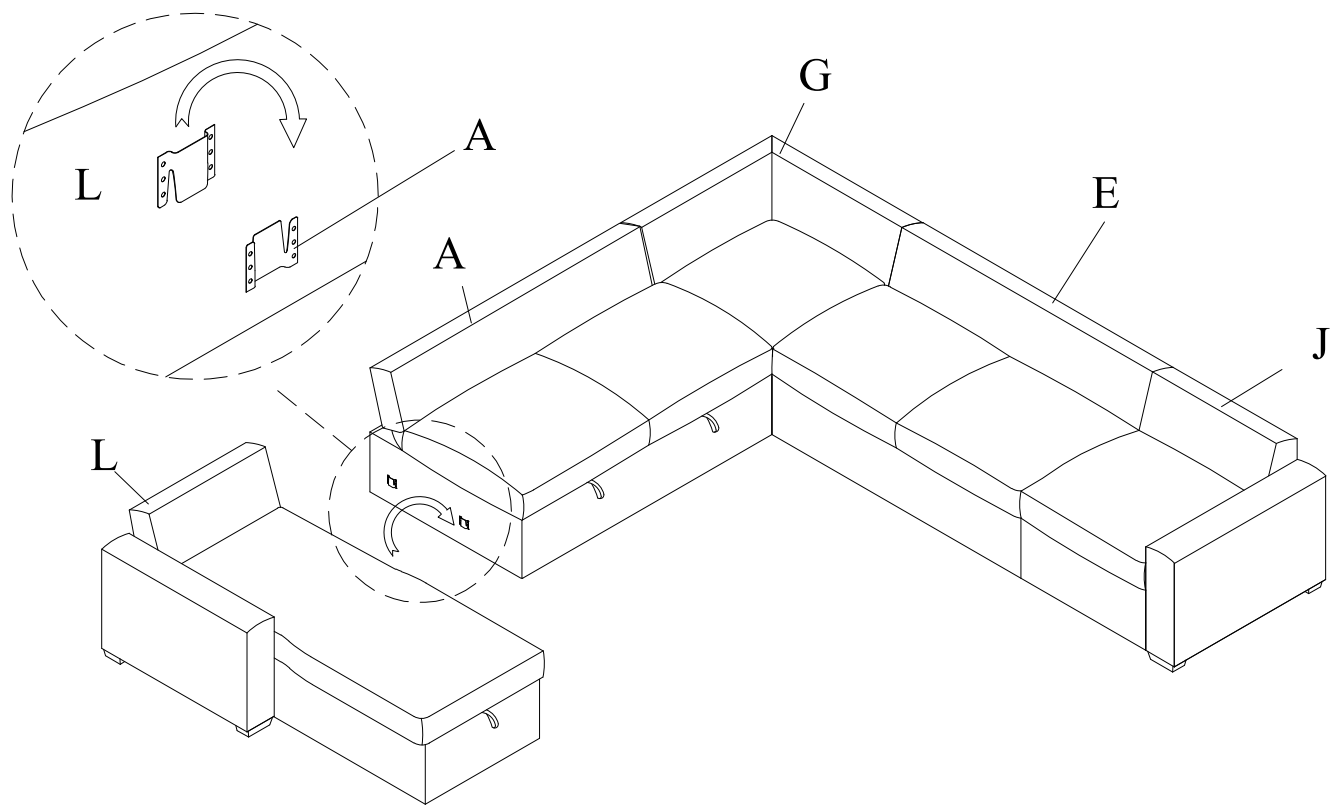

STEP 8: -VCCL+2ACL+CR+2A+AC also the OT

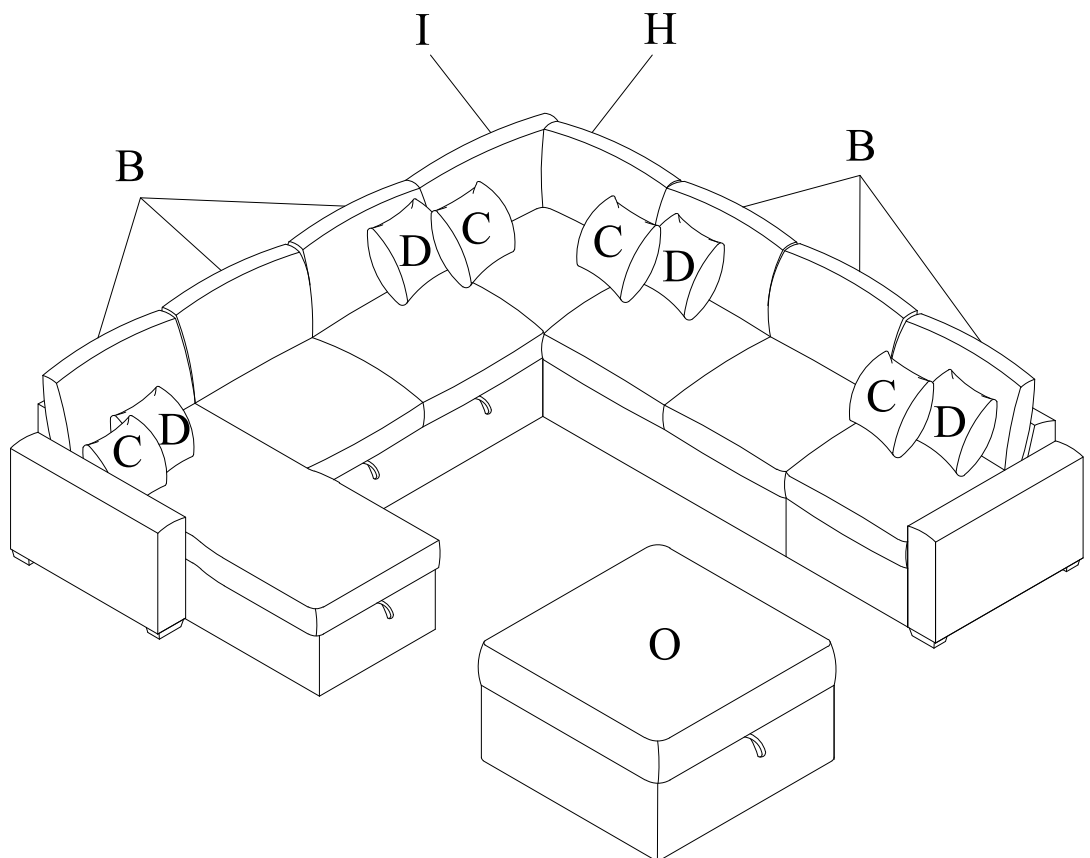

STEP 9: -VCCL+15ACL+CR+2A+ACCL

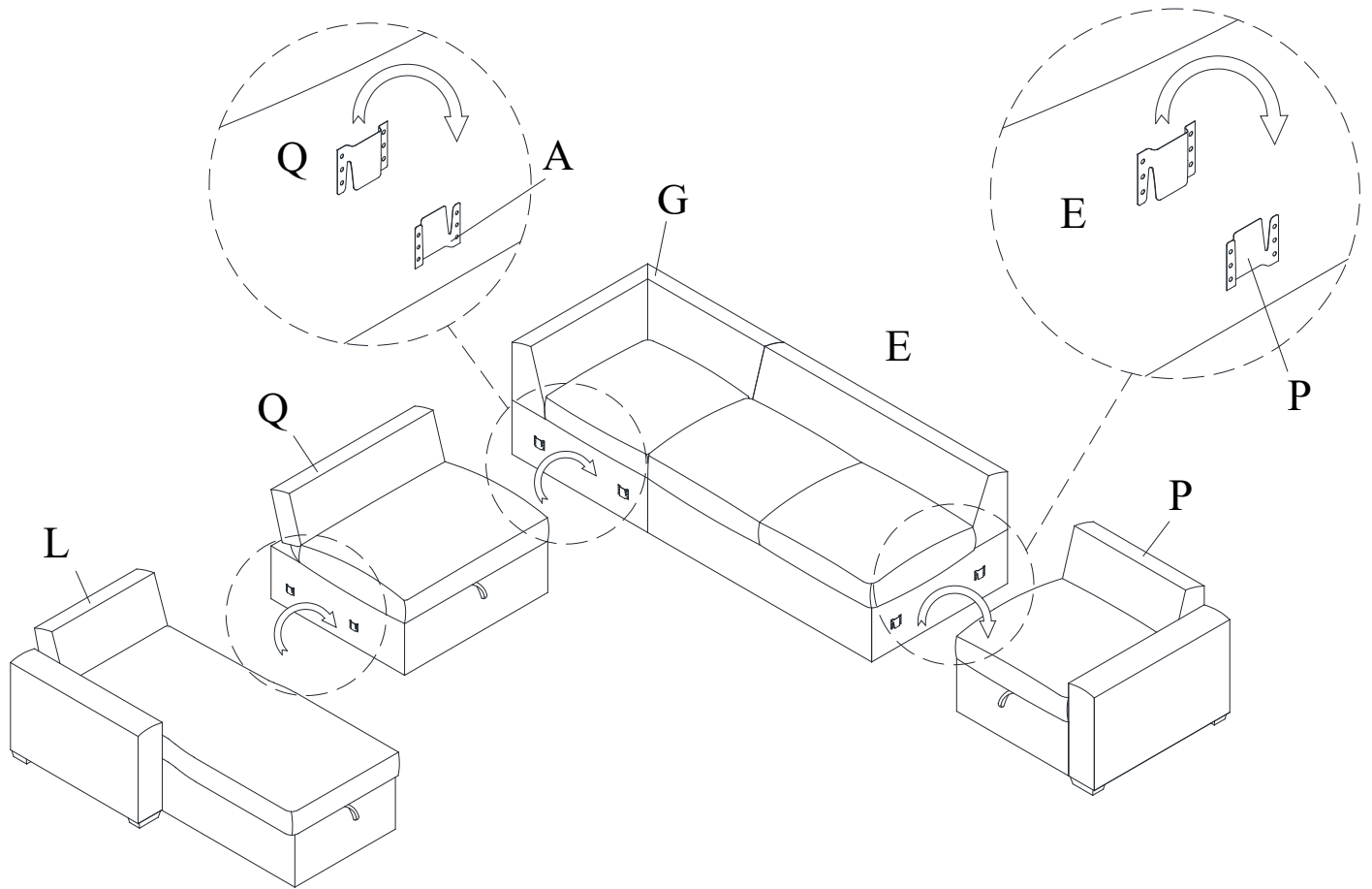

STEP 10: -VCCL+15ACL+CR+2A+ACCL also the OT

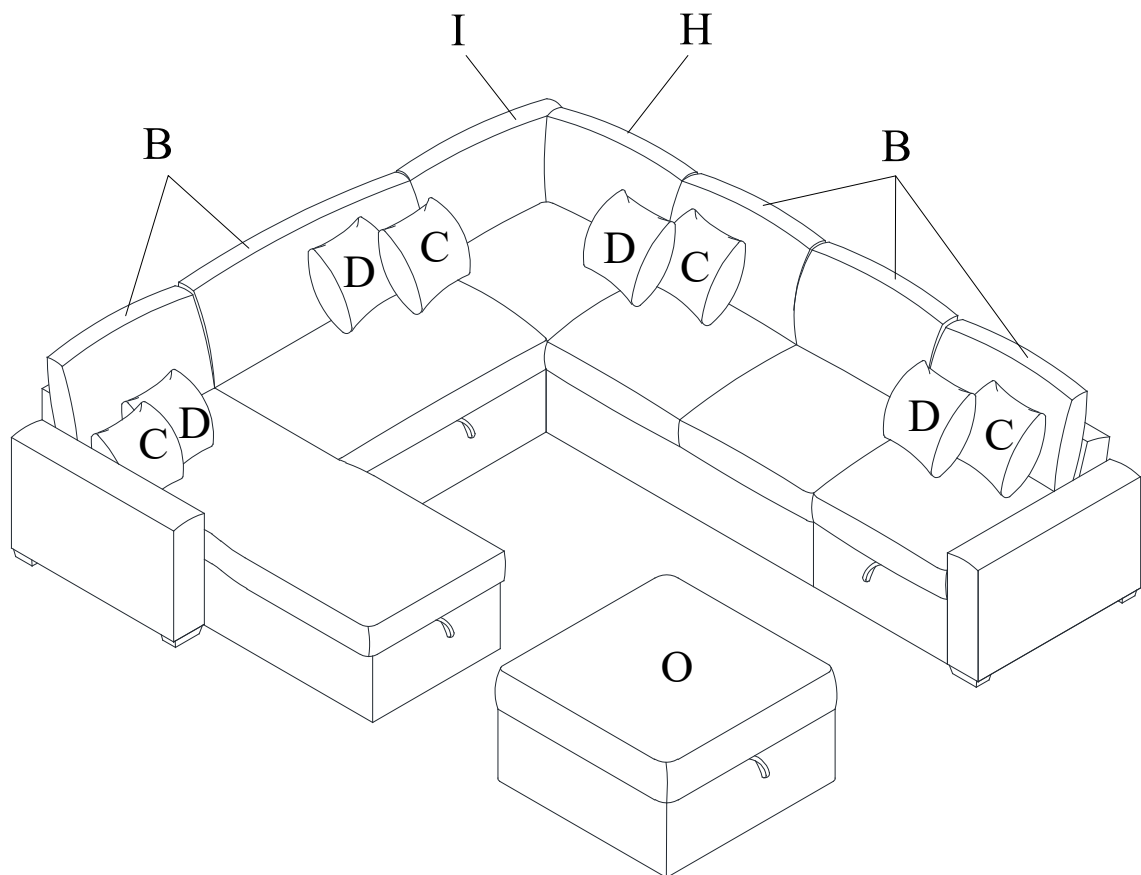

# TO CONVERT TO BED

## STEP 11:

Push the backrest forward to unlock it ( you will hear a click sound), this will release the backrest from the upright position. Then push the backrest all the way to the back until completely flat.

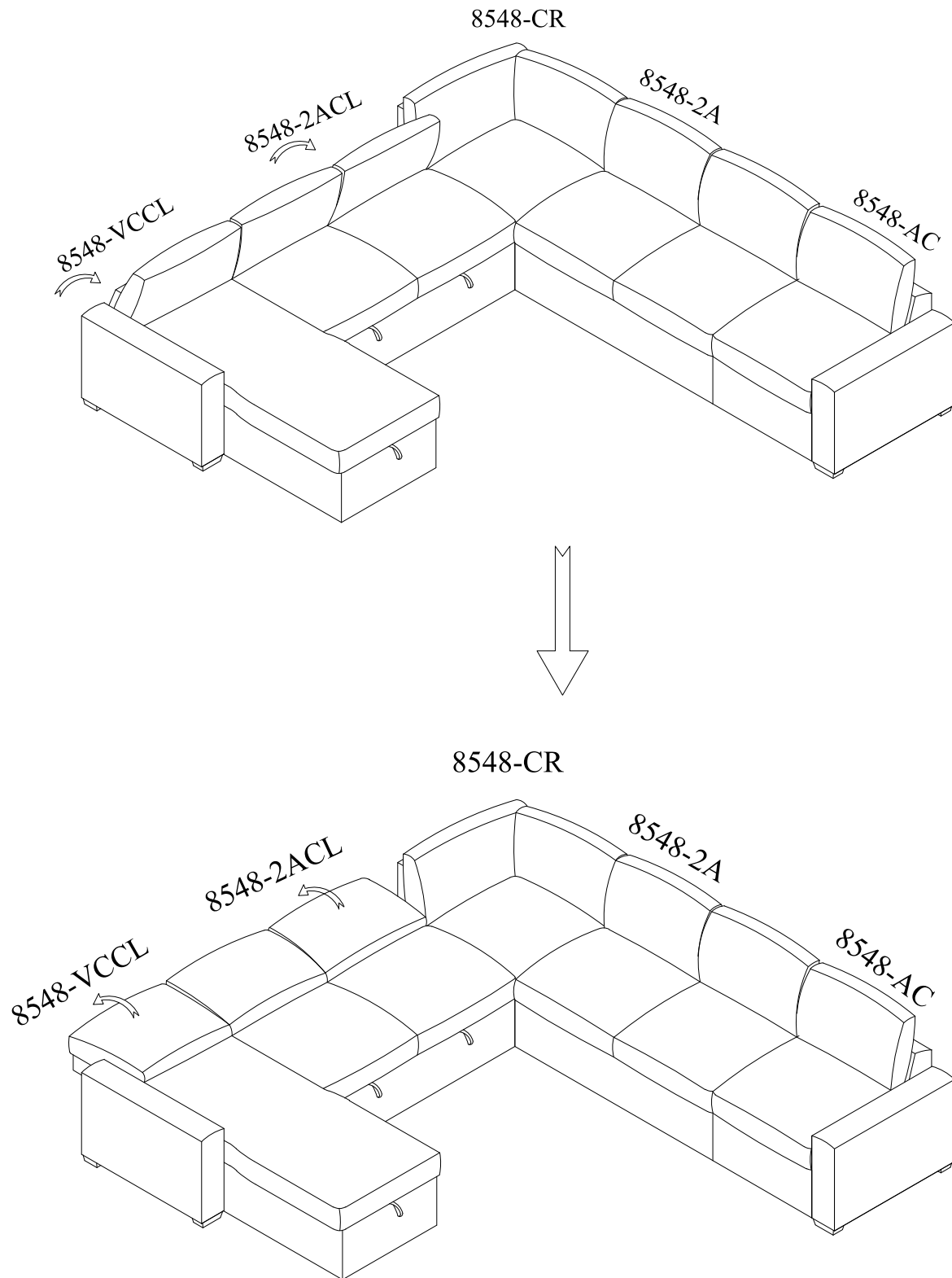

STEP 12:

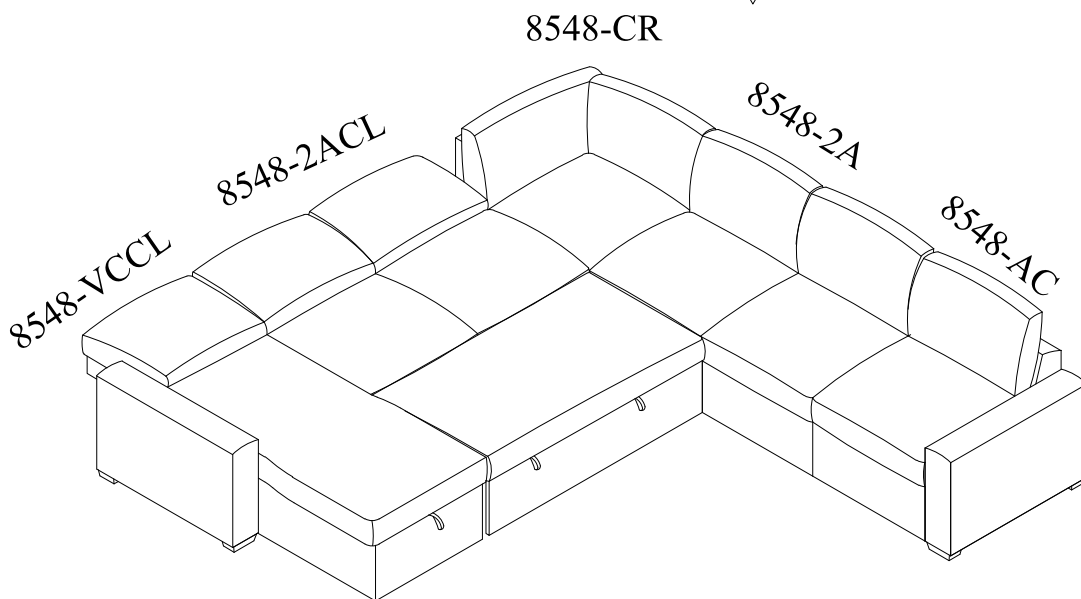
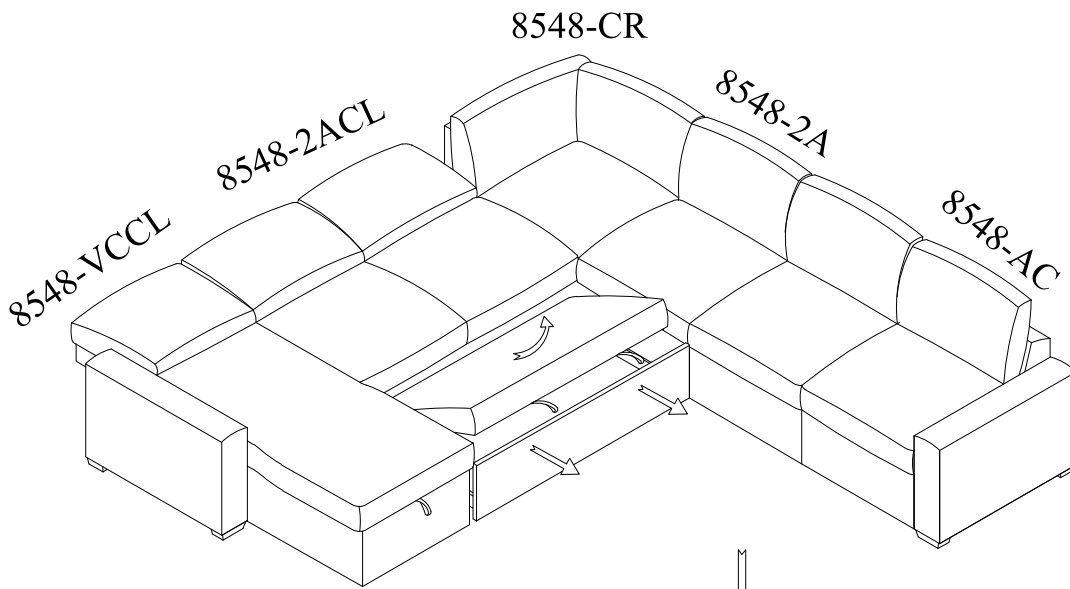
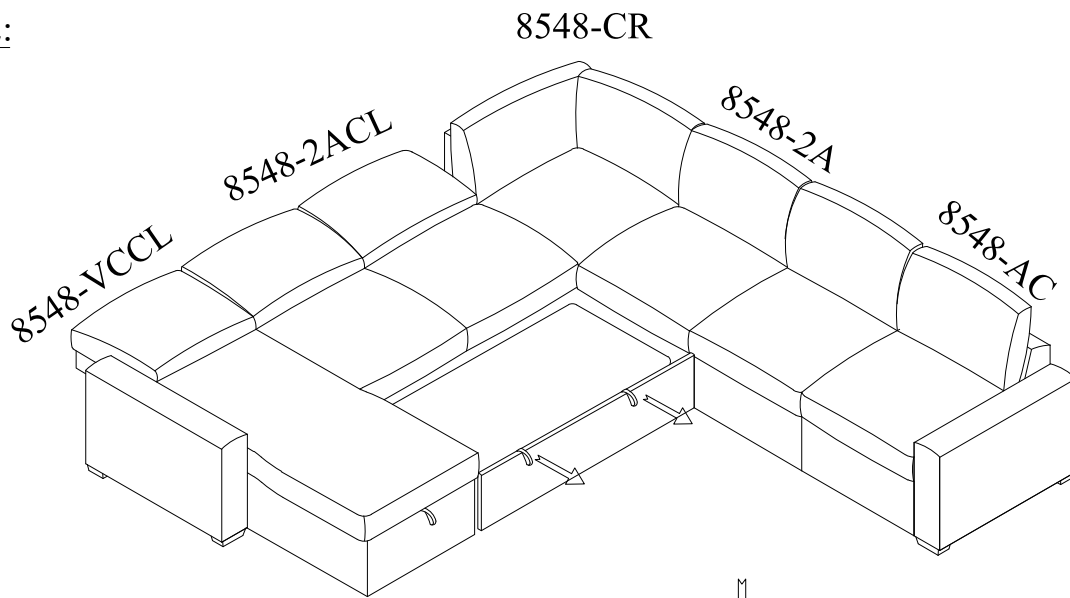

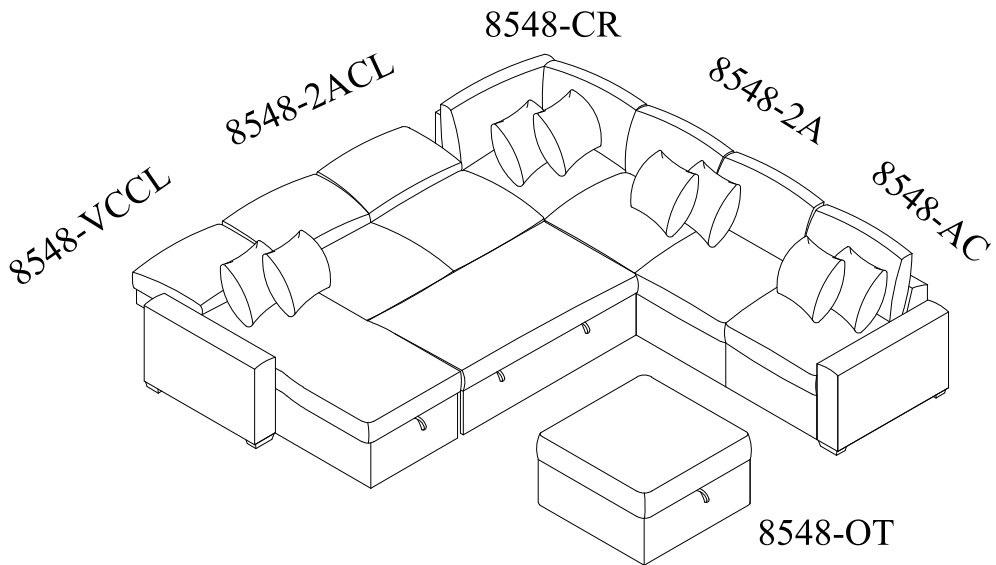
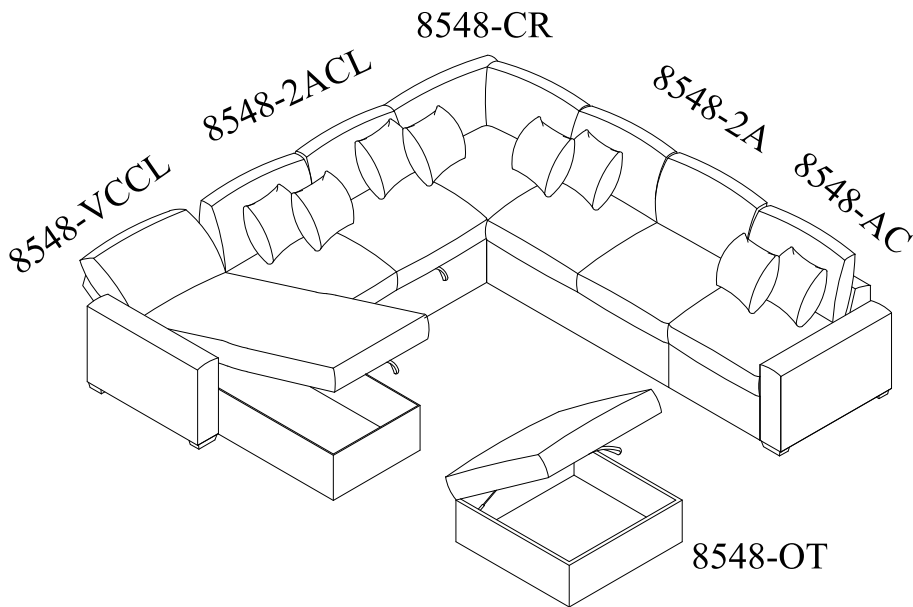
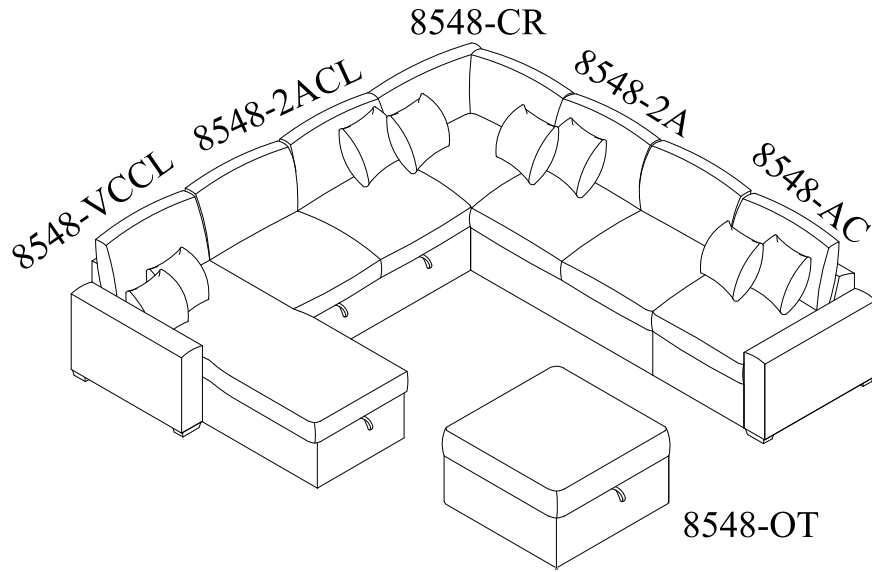

**BASED ON THE ABOVE INSTRUCTIONS YOU CAN IMPLEMENT OTHER OPTIONS SUGGESTED BELOW.**

Option 1: -AC+CR+2ACL+VCCL+A

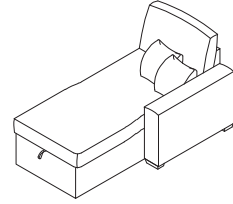
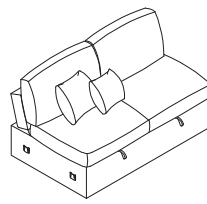
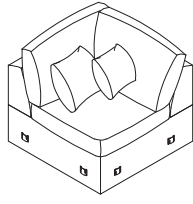
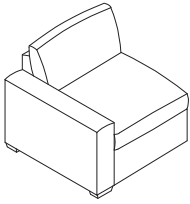

8548-CR

8548-AC

8548-2ACL

8548-VCCL

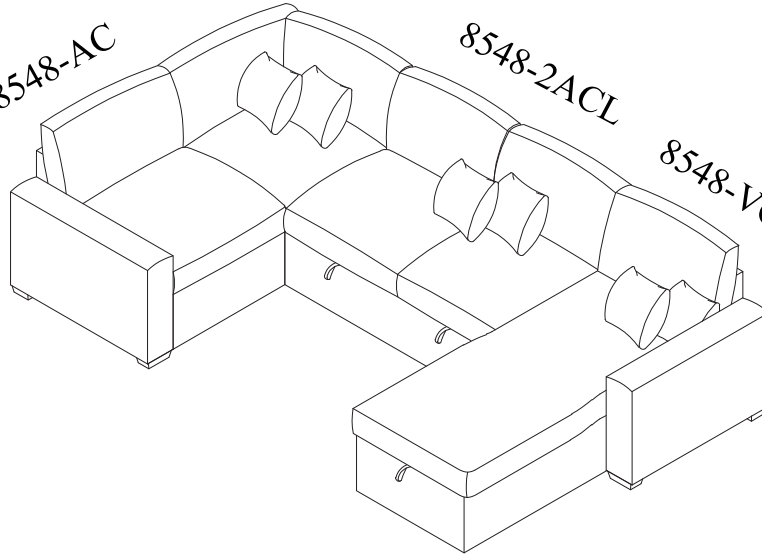

Option 2: -2A+VCCL+A

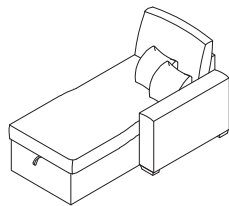
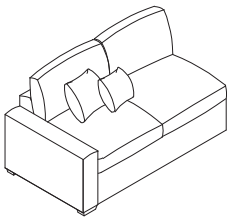

8548-2A

8548-VCCL

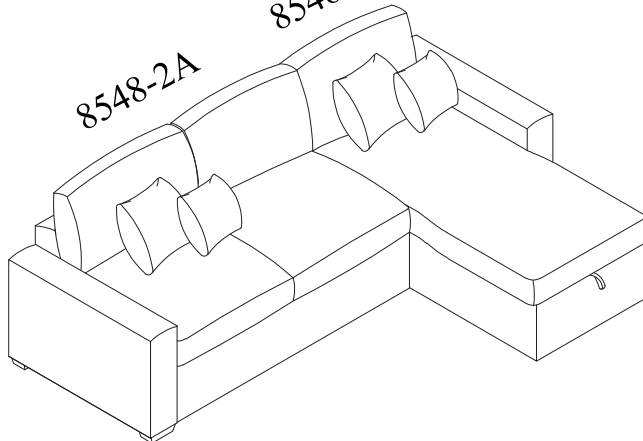

Option 3: -VCCL+2A+VCCL+A

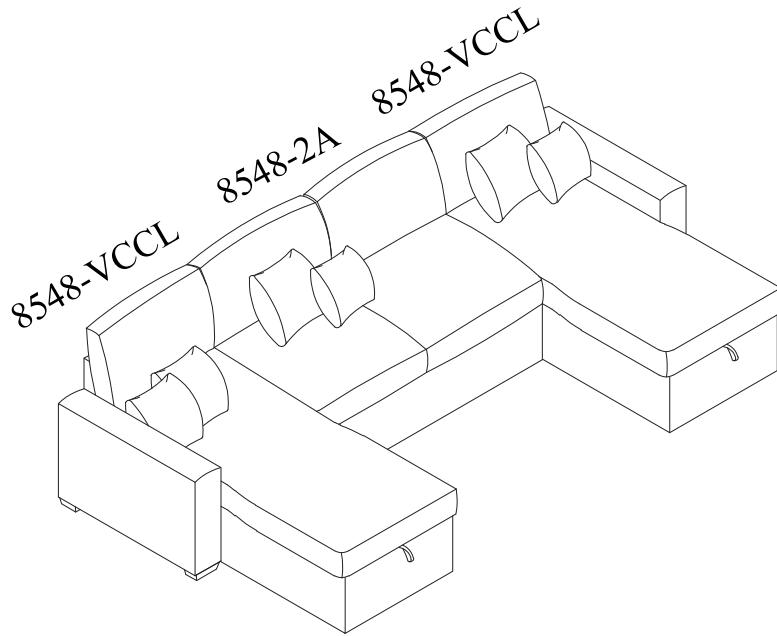
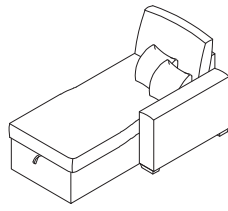
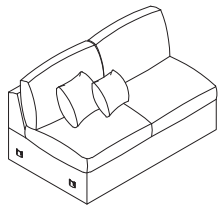
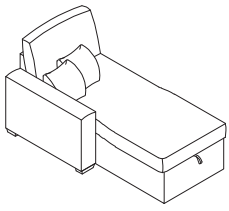

Option 4: -2ACL+CR+2A+VCCL+A

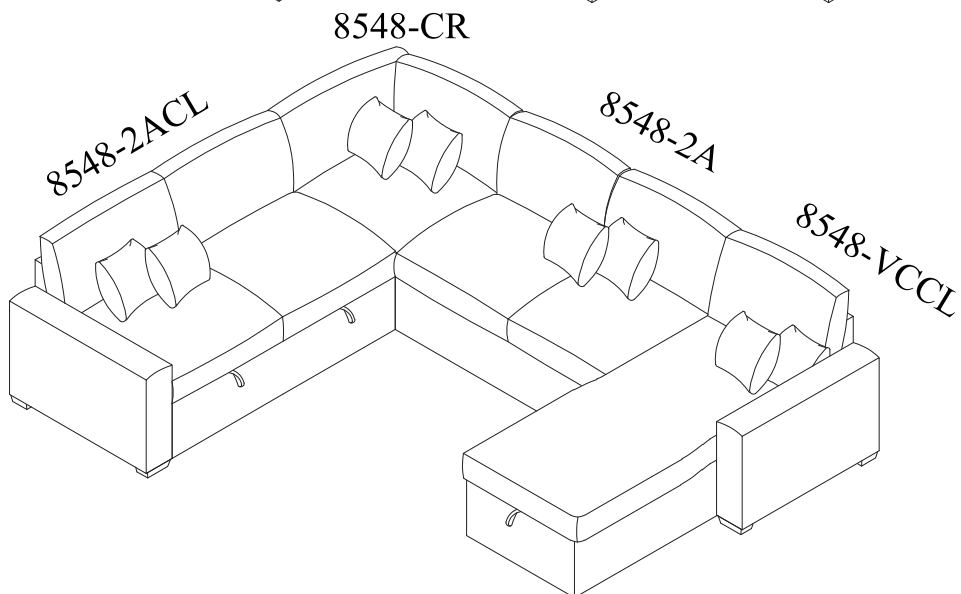
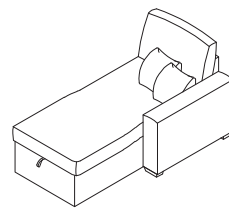
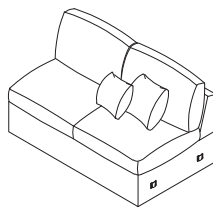
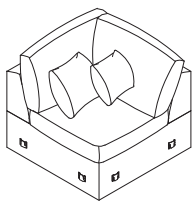
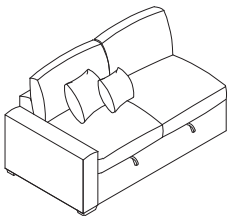

Option 5: -ACL+CR+2A+A

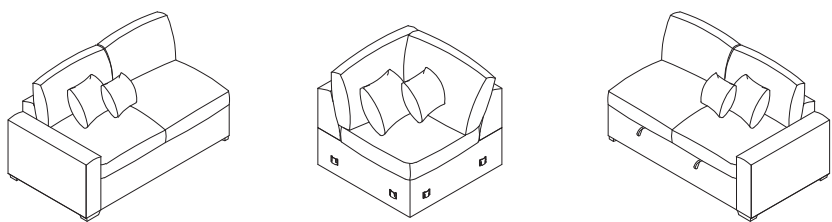

8548-CR

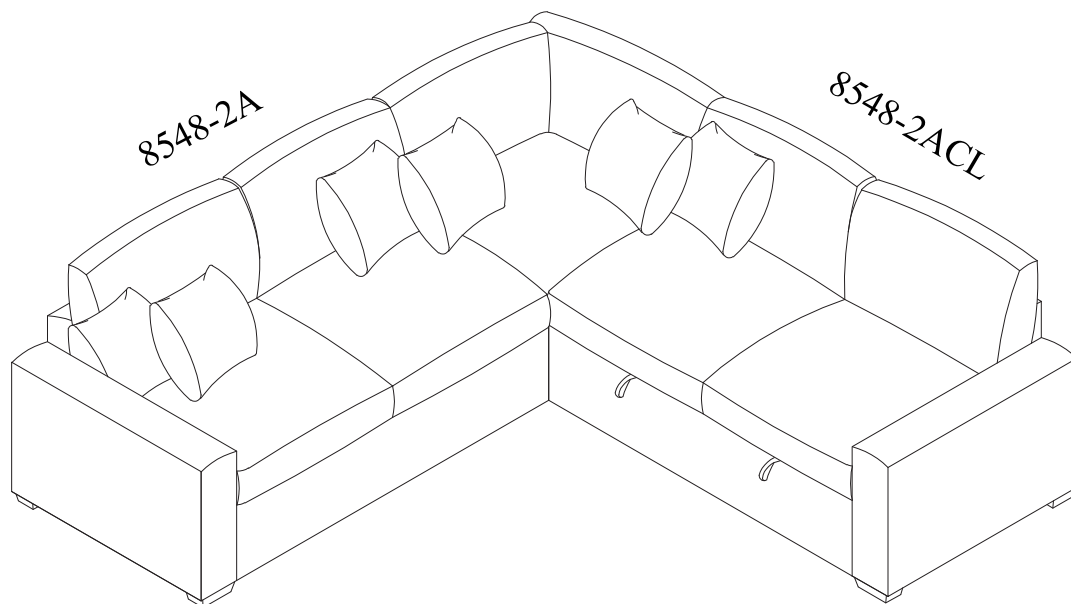

Option 6: -ACCL+CR+2A+A4

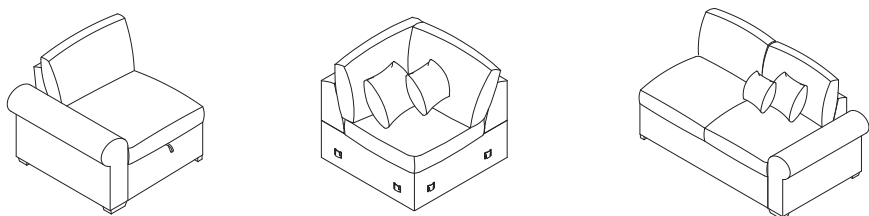

8548-CR

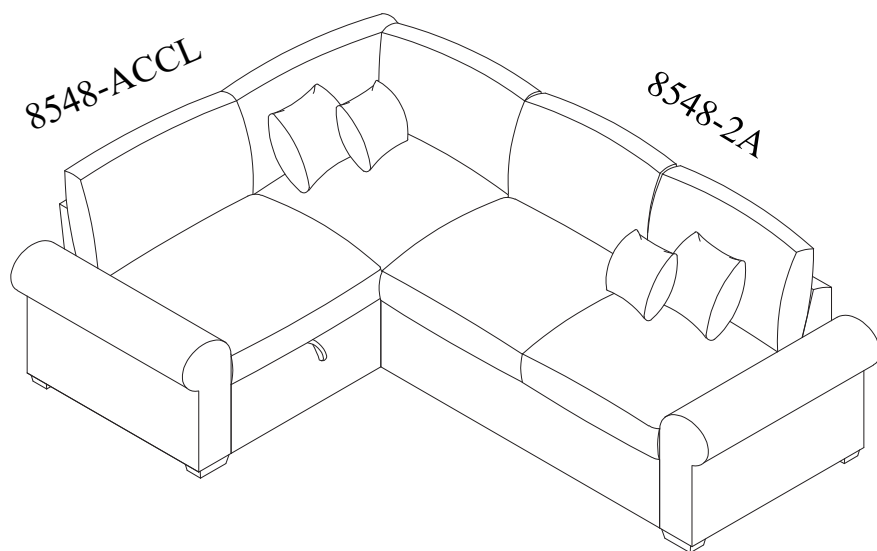

Option 7: -2A + CR + 15ACL + VCCL + A2

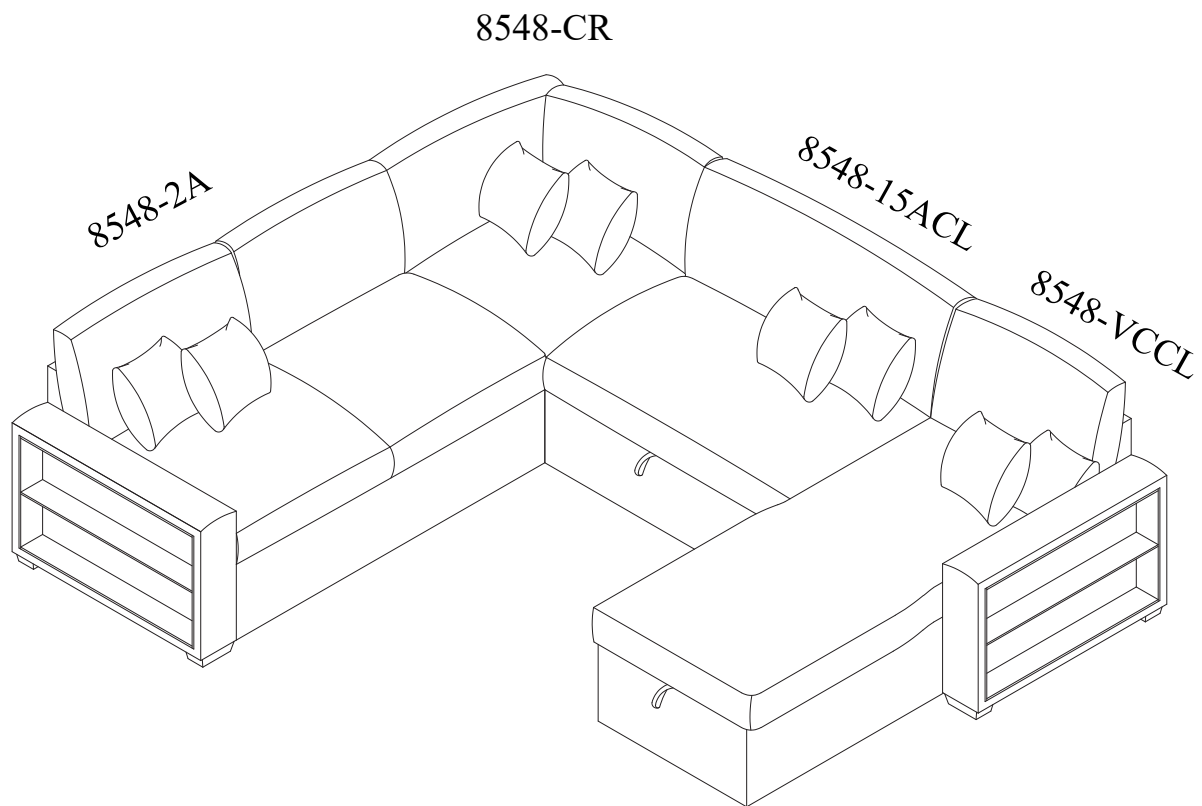
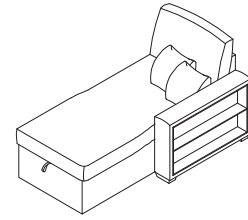
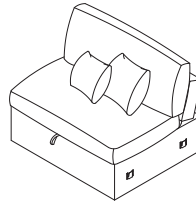
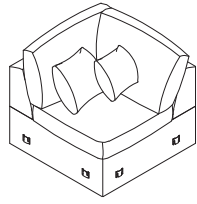
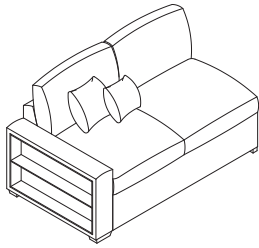

REMARK: For more options, please visit [www.homelegance.com](http://www.homelegance.com).

### Care Instruction for Microfiber Textured Fabric Furniture:

To maintain the original appearance of your microfiber textured fabric furniture, please follow the simple care procedures below:

- Avoid exposing furniture directly to sunlight or heating and air conditioning outlets. Sunlight and/or exposure to heating and air conditioning outlets will fade/damage microfiber textured fabric.
- Vacuum or wipe with a soft cloth to remove dust.
- Hardware may loosen over time. Periodically check to make sure all connection are tight. Re-tighten if necessary



For item use on wooden floor, hard surfaces or carpets, it is recommended to install protective pads under all legs and supports to prevent damages, scratches, and discoloration.

**CAUTION:** Changes or modifications not expressly approved by the party responsible for compliance could void the user's authority to operate the equipment.

Note: This equipment has been tested and found to comply with the limits for a Class B digital device, pursuant to part 15 of the FCC Rules. These limits are designed to provide reasonable protection against harmful interference in a residential installation. This equipment generates, uses and can radiate radio frequency energy and, if not installed and used in accordance with the instructions, may cause harmful interference to radio communications. However, there is no guarantee that interference will not occur in a particular installation. If this equipment does cause harmful interference to radio or television reception, which can be determined by turning the equipment on and off, the user is encouraged to try to correct the interference by one or more of the following measures:

- Reorient or relocate the receiving antenna.
- Increase the separation between the equipment and receiver.
- Connect the equipment into an outlet on a circuit different from that to which the receiver is connected.
- Consult the dealer or an experienced radio/TV technician for help.



**WARNING:** To avoid serious injury:

- Carefully and strictly follow assembly instructions.  
Improper assembly of furniture can result in structural failure, instability of the product or tip-over.
- Monitor and carefully control the assembly components.  
These include small parts and hardware that may present a choking hazard to small children.
- Monitor and carefully control the assembly components.  
These include small parts and hardware that may present a choking hazard to small children.
- Where provided, wall mounting hardware should always be used.  
As prescribed in these instructions to anchor furniture to walls. Proper use of the wall mounting can significantly reduce the potential for furniture tip-over and crush injuries.

#### Technique Parameter

- USB Input voltage: 5V/2.0A
- USB output voltage: 5V/2.0A
- Charging efficiency: 75% MAX

#### USB System Customer Service Contact

Information: Toll Free Phone Number:

718-813-9564 POWER TECHNOLOGY TRADING MANUFACTURE CO.,LTD

Address: 1001 S.Main St STE

500 Kalispell, MT 59901 United States