



ASSEMBLY INSTRUCTION

ITEM NO.: 4215PP-1

KID'S CHAIR



The legs are stored in a box inside the carton, please take out for assembly.
 Note: Do not use power tools for assembly. Power tools increase the risk of over tightening which lead to splitting or cracking the wood.

COMPONRNT LIST

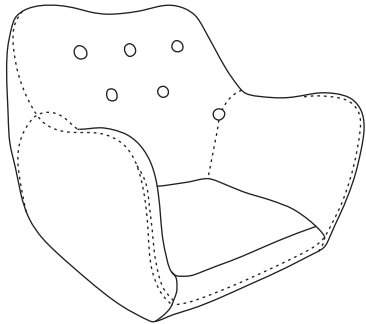
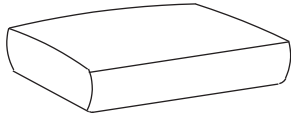
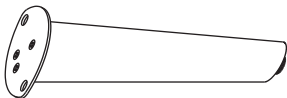
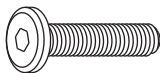
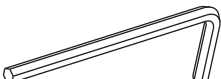
No	Drawing	Description	Qty
A		SEAT	1 PC
B		SEAT CUSHION	1 PC
C		WOODEN LEG /w METAL PLAT (3 1/8" × 2 3/16" × H 6 1/8)	4 PCS
D		BOLT (Ø9/16" × L7/8")	8 PCS
E		ALLEN KEY	1 PC

Step 1:

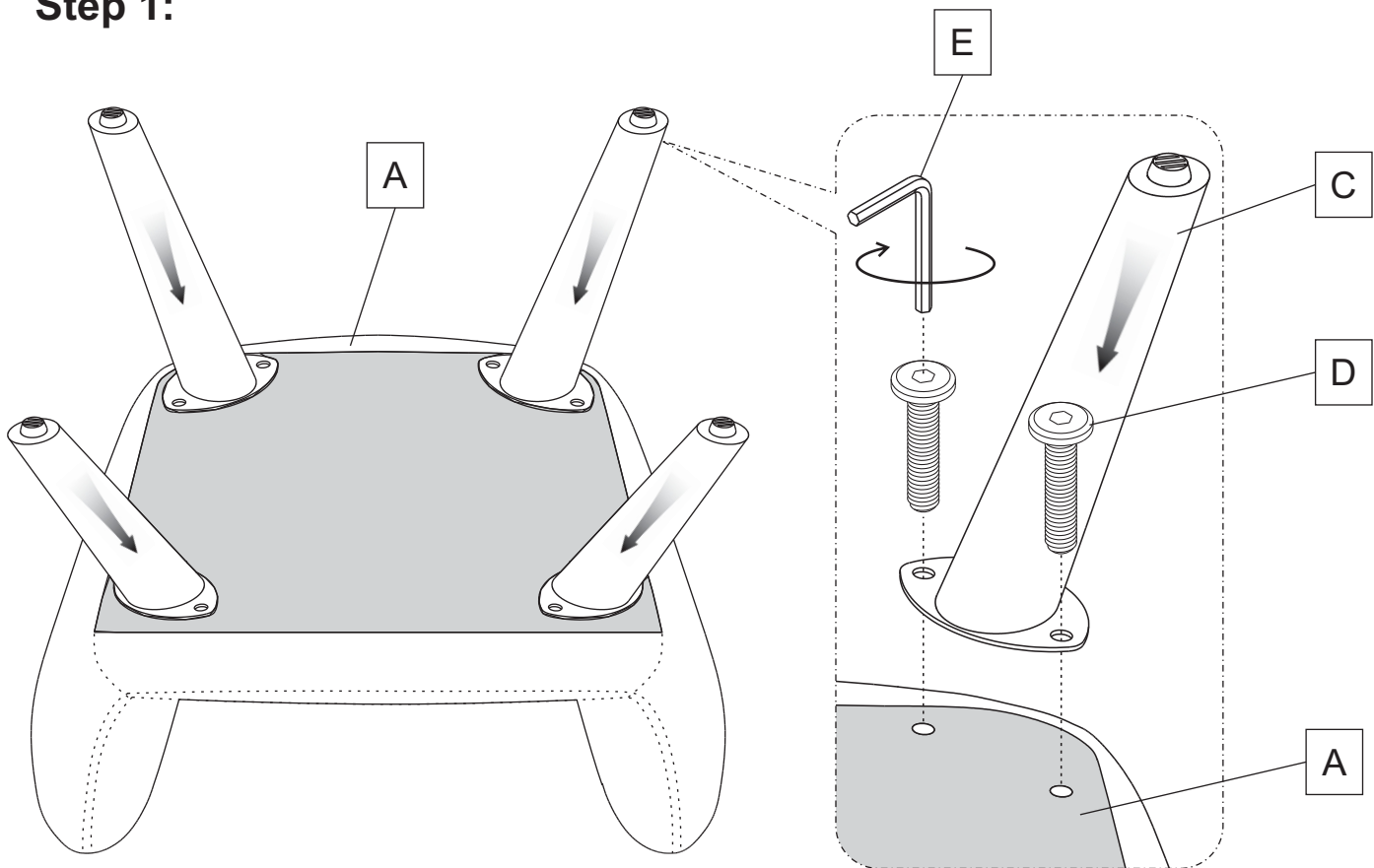

Step 2:

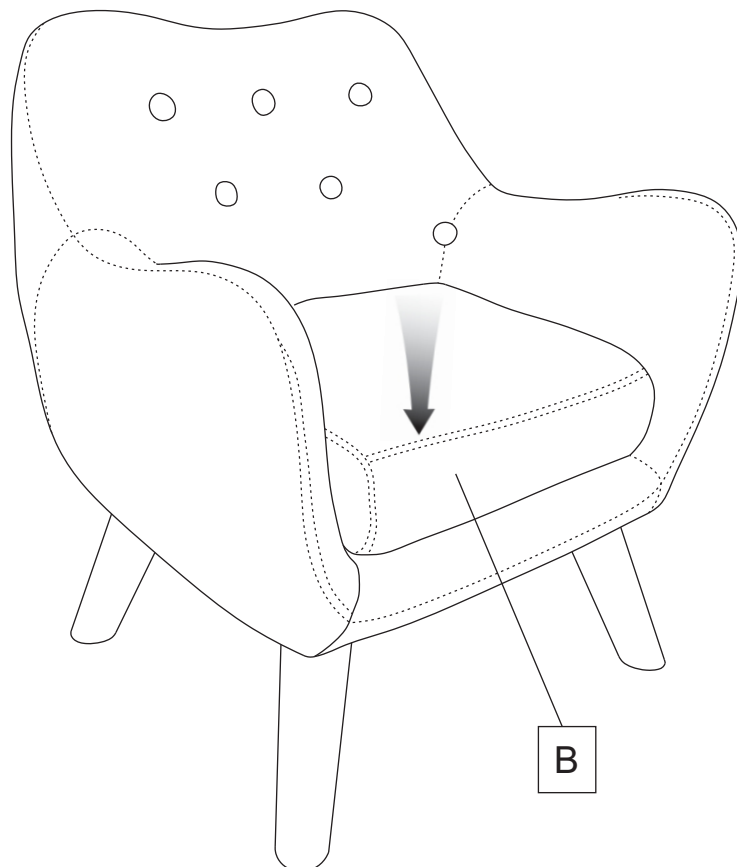

COMPLETED

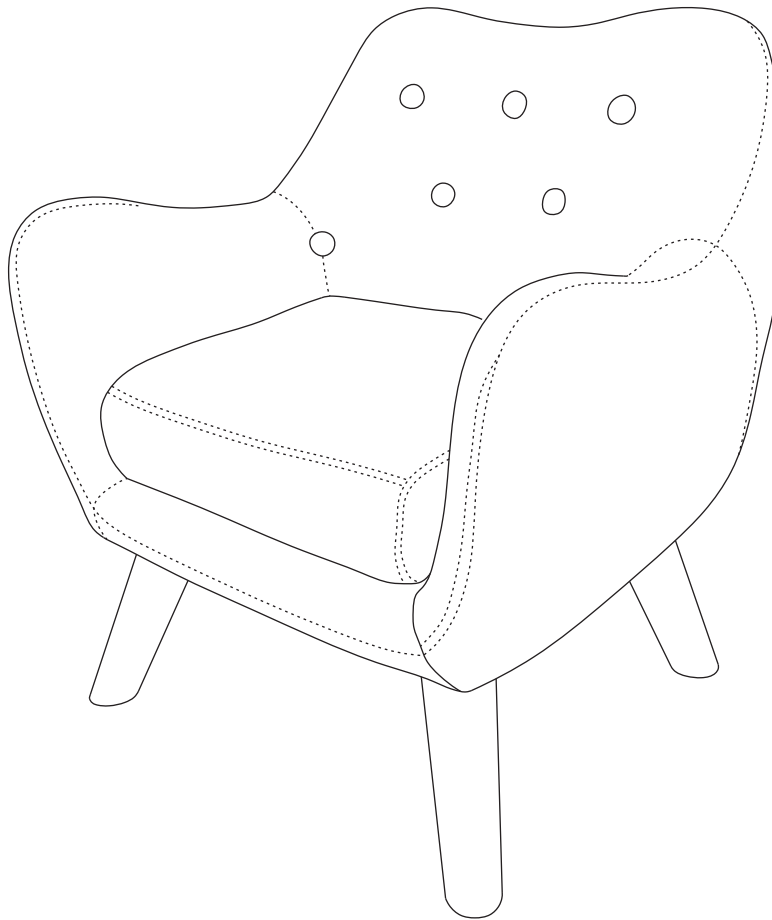

Care Instruction for Textured Fabric Furniture:

In order to maintain the original appearance of your textured fabric Furniture, please follow below simple care procedures:

- Avoid exposing furniture directly to sunlight or heating and air conditioning outlets. Sunlight and or exposure to heating and air conditioning outlets will fade/damage textured fabric.
- Vacuum or wipe with a soft cloth to remove dust.
- Hardware may loosen over time. Periodically check to make sure all connections are tight, Re-tighten if necessary.



For items use on wooden floor, hard surfaces or carpets, it is recommended to Install protective pads under all legs and supports to avoid/prevent from damages/scratches and discoloration.