





# Assembly Instruction



## END TABLE

### ITEM NO.: 3644-04

**NOTE:** Do not use power tools for assembly. Power tools increase the risk of over tightening which leads to splitting or cracking the wood.

#### COMPONENT LIST

NO.	DRAWING	QTY	DESCRIPTION
A		1	Glass Top
B		2	Leg

NO.	DRAWING	QTY	DESCRIPTION
C		8	Allen bolt 8X16MM
D		1	Allen Key
E		8	Washer 10x19mm

#### STEP#1

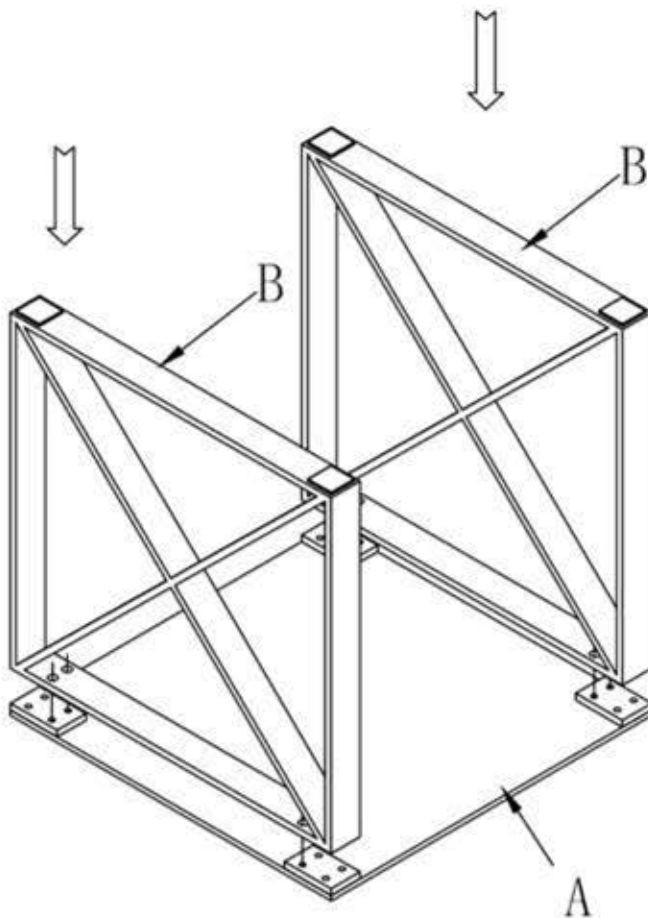

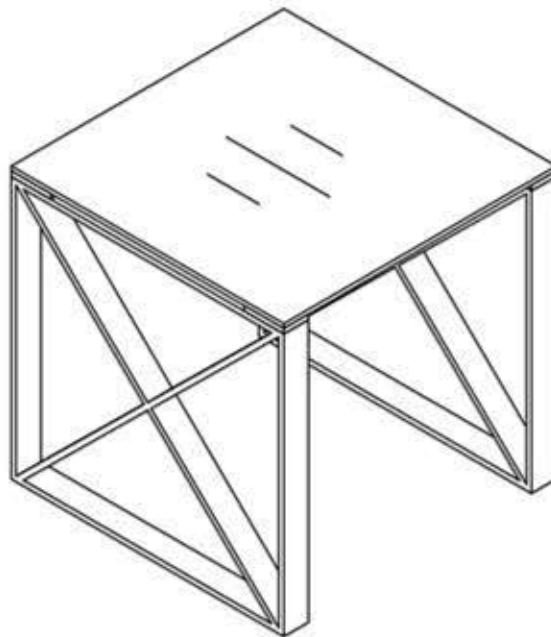
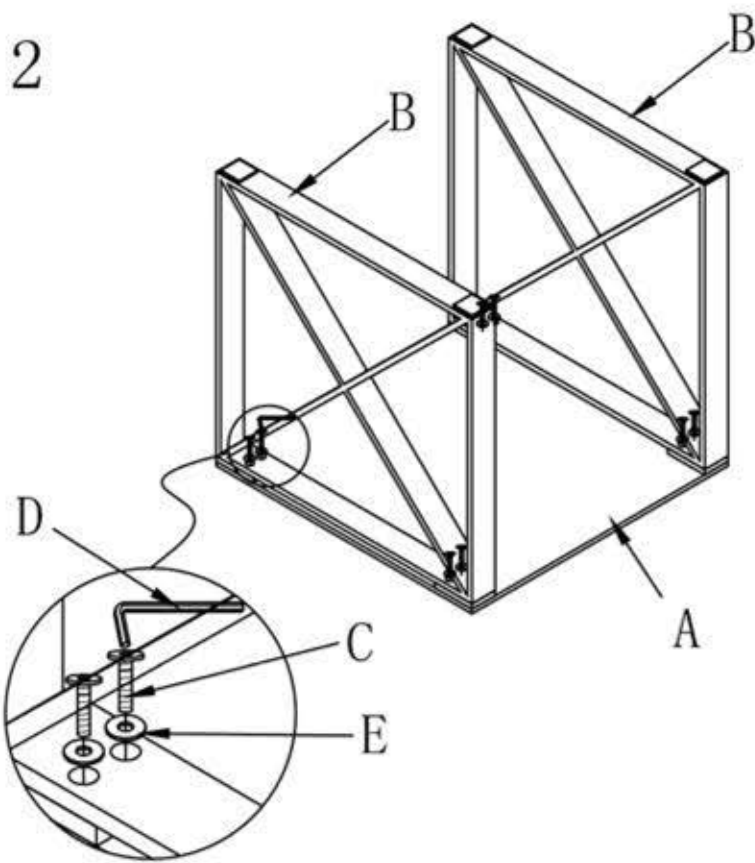

For items use on wooden floor, hard surfaces or carpets, it is recommended to Install protective pads under all legs and supports to avoid/prevent from damages/scratches and discoloration.